

# INTERNATIONAL CLASSIFICATION OF THE FIGURATIVE ELEMENTS OF MARKS

under the

**Vienna Agreement**

of June 12, 1973

THIRD EDITION



WORLD INTELLECTUAL PROPERTY ORGANIZATION

GENEVA

1993

# INTERNATIONAL CLASSIFICATION OF THE FIGURATIVE ELEMENTS OF MARKS

under the

**Vienna Agreement**

of June 12, 1973

THIRD EDITION



WORLD INTELLECTUAL PROPERTY ORGANIZATION

GENEVA

1993

WIPO PUBLICATION  
No. 502 (E)

ISBN 92-805-0419-3

WIPO 1993

Reprinted in 1995

Printed by WIPO, Geneva

## TABLE OF CONTENTS

	<u>Page</u>
Preface . . . . .	5
Vienna Agreement Establishing an International Classification of the Figurative Elements of Marks of June 12, 1973, as amended on October 1, 1985 . . . . .	9
Resolution Adopted by the Diplomatic Conference of Vienna on June 8, 1973 . . . . .	20
Recommendations Adopted by the Committee of Experts on May 13, 1987 and on June 24, 1992 . . . . .	21
International Classification of the Figurative Elements of Marks	
Guidance for the User . . . . .	23
Table of Categories . . . . .	24
Table of Categories and Divisions, with Explanatory Notes . . . . .	25
List of Categories, Divisions and Sections, with Explanatory Notes . . . . .	35
Examples of Figurative Elements Relating to Certain Divisions . . . . .	83



## PREFACE

### HISTORY OF THE CLASSIFICATION OF FIGURATIVE ELEMENTS

At the request of a number of industrial property offices of member countries of the Paris Union, the United International Bureaux for the Protection of Intellectual Property (BIRPI)—predecessor of the World Intellectual Property Organization (WIPO)—began working with a Committee of Experts set up in 1967 by the BIRPI Interunion Coordination Committee on the drafting of an international classification of the figurative elements of marks. The classification was introduced by an agreement concluded on June 12, 1973, at the Vienna Diplomatic Conference.

The countries party to the Vienna Agreement Establishing an International Classification of the Figurative Elements of Marks (hereinafter referred to as "the Vienna Agreement" and "the Classification," respectively) constitute a Special Union within the framework of the Paris Union for the Protection of Industrial Property. They have adopted and apply a common classification for the figurative elements of marks.

The Vienna Agreement entered into force on August 9, 1985. The following countries are party to it (as of that date): France, Luxembourg, Netherlands, Sweden, Tunisia.

### PURPOSE AND SCOPE OF THE CLASSIFICATION

The purpose of the Classification is essentially the practical one of facilitating trademark anticipation searches and obviating substantial reclassification work when documents are exchanged at the international level. What is more, the countries party to the Vienna Agreement no longer need to draw up their own national classification or keep an existing one up to date.

Article 4 of the Vienna Agreement provides that, subject to the requirements prescribed by the Agreement itself, the scope of the Classification is that attributed to it by each country of the Special (Vienna) Union, and that, in particular, the Classification does not bind the countries of the Special Union in respect of the extent of the protection afforded to the mark. Thus, any country party to the Vienna Agreement may give the Classification legal scope, over and above the purely administrative implications under the Vienna Agreement.

### STRUCTURE OF THE CLASSIFICATION

The Classification constitutes a hierarchical system that proceeds from the general to the particular, dividing all figurative elements into categories, divisions and sections. Where appropriate, explanatory notes have been introduced. They concern either the Classification as a whole or any given category, division or section.

The sections are of two kinds. In addition to main sections, there are auxiliary sections intended for figurative elements that are already covered by the main sections, but which it is considered useful to group according to a particular criterion for ease of anticipation searching.

Every category, division and section has been given a number according to a special coding system. Every figurative element in a section is referred to by three numbers: the first, which may be any number from 1 to 29, denotes the category, the second, which may be any number from 1 to 19, the division, and the third, which may be any number from 1 to 25, the section. For instance, the representation of "a young girl eating" belongs to Category 2 (Human beings), Division 5 (Children), Main Section 3 (Girls) and Auxiliary Section 18 (Children drinking or eating).

The number of divisions and sections varies according to the categories and divisions to which they belong. Within the divisions and sections, certain numbers have been left vacant in order to permit the introduction of new divisions or sections when necessary.

This publication contains the third edition of the Classification, which comprises a total of:

29 categories,  
144 divisions and  
1,596 sections.

The examples of figurative elements relating to certain divisions, which are reproduced on pages 83 to 102, are included for information purposes only, and are therefore not an integral part of the Classification.

#### USE OF THE CLASSIFICATION

The countries party to the Vienna Agreement may apply the Classification either as a principal or as a subsidiary system. Thus, they have the possibility of continuing, if they see fit, to use their national classification at the same time as the Vienna Classification, either as a transitional or as a permanent measure.

The competent offices of countries party to the Vienna Agreement are obliged to include in the official documents and publications relating to registrations and renewals of marks the numbers of the categories, divisions and sections in which the figurative elements of those marks have been placed. "Documents and publications" means, in particular, entries in the trademark register, registration and renewal certificates and publications of registrations and renewals in office journals or gazettes.

The numbers of the categories, divisions and sections appearing in official documents and publications relating to registrations should be preceded, for ease of comprehension, by the full name "Classification of Figurative Elements" or by the abbreviation CFE (see page 21). It is recommended that the edition of the Vienna Classification according to which figurative elements of marks are classified be indicated by an Arabic numeral in round brackets, for example, CFE (3).

The Classification is sufficiently detailed for each section to contain only a relatively small number of figurative elements, even when used by large industrial property offices, thereby facilitating anticipation searches. It is perhaps too detailed, however, for offices that register relatively few marks. Countries party to the Vienna Agreement may therefore declare that they reserve the right not to include the numbers of all or some of the sections in official documents and publications relating to registrations and renewals of marks (Article 4(5) of the Vienna Agreement). Moreover, the "auxiliary" sections, the numerical code of which is preceded by an A in the Classification, are in any event not mandatory; national offices may use them at their discretion.

#### REVISIONS OF THE CLASSIFICATION

The Classification published here is based on that approved on June 22, 1973, at the Vienna Diplomatic Conference.

Pending the entry into force of the Vienna Agreement, a provisional Committee of Experts, set up under the Resolution adopted by the Vienna Diplomatic Conference on June 8, 1973 (see page 20), met in 1975 and 1976 to draw up proposals for amendments and additions to the original version of the Classification. Those proposals, after having been incorporated in the original version of the Classification, were published in a provisional edition in 1977.

Following the entry into force of the Vienna Agreement, the Committee of Experts set up under Article 5 of the Agreement, at its first session, in Geneva in May 1987, approved the majority of the amendments and additions proposed by the provisional Committee of Experts.

At its second session, held in Geneva in June 1992, the Committee of Experts adopted a number of further amendments and additions to the Vienna Classification. The adopted changes have been incorporated in the Classification.

#### EDITIONS OF THE CLASSIFICATION

The first edition of the Classification was published in 1973 and the second in 1988.

The present volume contains the third edition of the English version of the Classification adopted by the Committee of Experts at its second session, in June 1992. The third edition, which entered into force on January 1, 1993, replaces the previous editions.

#### LANGUAGES OF THE CLASSIFICATION

The Classification has been established in English and French, both texts being equally authentic. Official texts of the third edition will be established in other languages, as provided for in Article 3(2) of the Vienna Agreement.

\* \* \* \*

This publication may be ordered from the World Intellectual Property Organization (WIPO), 34, chemin des Colombettes, 1211 Geneva 20 (Switzerland) at the price of 50 Swiss francs per volume, which is also the price of the corresponding French edition.

Geneva, January 1, 1993





**Vienna Agreement  
Establishing an International Classification  
of the Figurative Elements of Marks**

Done at Vienna on June 12, 1973, and  
amended on October 1, 1985

TABLE OF CONTENTS\*

- Article 1: Establishment of a Special Union; Adoption of an International Classification
- Article 2: Definition and Deposit of the Classification of Figurative Elements
- Article 3: Languages of the Classification of Figurative Elements
- Article 4: Use of the Classification of Figurative Elements
- Article 5: Committee of Experts
- Article 6: Notification, Entry Into Force and Publication of Amendments and Additions and of Other Decisions
- Article 7: Assembly of the Special Union
- Article 8: International Bureau
- Article 9: Finances
- Article 10: Revision of the Agreement
- Article 11: Amendment of Certain Provisions of the Agreement
- Article 12: Becoming Party to the Agreement
- Article 13: Entry Into Force of the Agreement
- Article 14: Duration of the Agreement
- Article 15: Denunciation
- Article 16: Disputes
- Article 17: Signature, Languages, Depositary Functions, Notifications

---

\* This Table of Contents is added for the convenience of the reader. It does not appear in the signed text of the Agreement.

The Contracting Parties,

Having regard to Article 19 of the Paris Convention for the Protection of Industrial Property, of March 20, 1883, as revised at Brussels on December 14, 1900, at Washington on June 2, 1911, at The Hague on November 6, 1925, at London on June 2, 1934, at Lisbon on October 31, 1958, and at Stockholm on July 14, 1967,

Have agreed as follows:

#### **Article 1**

##### **Establishment of a Special Union; Adoption of an International Classification**

The countries to which this Agreement applies constitute a Special Union and adopt a common classification for the figurative elements of marks (hereinafter designated as "the Classification of Figurative Elements").

#### **Article 2**

##### **Definition and Deposit of the Classification of Figurative Elements**

(1) The Classification of Figurative Elements comprises a list of categories, divisions and sections in which the figurative elements of marks are classified, together with, as the case may be, explanatory notes.

(2) The Classification of Figurative Elements is contained in one authentic copy, in the English and French languages, signed by the Director General of the World Intellectual Property Organization (hereinafter designated respectively as "the Director General" and "the Organization") and deposited with him at the time that this Agreement is opened for signature.

(3) The amendments and additions referred to in Article 5(3)(i) shall also be contained in one authentic copy, in the English and French languages, signed by the Director General and deposited with him.

#### **Article 3**

##### **Languages of the Classification of Figurative Elements**

(1) The Classification of Figurative Elements shall be established in the English and French languages, both texts being equally authentic.

(2) The International Bureau of the Organization (hereinafter designated as "the International Bureau") shall establish, in consultation with the interested Governments, official texts of the Classification of Figurative Elements in the languages which the Assembly referred to in Article 7 may designate in accordance with paragraph (2)(a)(vi) of that Article.

**Article 4**

**Use of the Classification of Figurative Elements**

(1) Subject to the requirements prescribed by this Agreement, the scope of the Classification of Figurative Elements shall be that attributed to it by each country of the Special Union. In particular, the Classification of Figurative Elements shall not bind the countries of the Special Union in respect of the extent of the protection afforded to the mark.

(2) The competent Offices of the countries of the Special Union shall have the right to use the Classification of Figurative Elements either as a principal or as a subsidiary system.

(3) The competent Offices of the countries of the Special Union shall include in the official documents and publications relating to registrations and renewals of marks the numbers of the categories, divisions and sections in which the figurative elements of those marks are to be placed.

(4) The said numbers shall be preceded by the words "Classification of Figurative Elements" or an abbreviation thereof to be determined by the Committee of Experts referred to in Article 5.

(5) Any country may, at the time of its signature or of the deposit of its instrument of ratification or accession, declare that it does not undertake to include the numbers of all or some of the sections in official documents and publications relating to registrations and renewals of marks.

(6) If any country of the Special Union entrusts the registration of marks to an intergovernmental authority, it shall take all possible measures to ensure that that authority uses the Classification of Figurative Elements in accordance with this Article.

**Article 5**

**Committee of Experts**

(1) A Committee of Experts shall be set up in which each country of the Special Union shall be represented.

(2) (a) The Director General may, and, if requested by the Committee of Experts, shall, invite countries not members of the Special Union which are members of the Organization or party to the Paris Convention for the Protection of Industrial Property to be represented by observers at meetings of the Committee of Experts.

(b) The Director General shall invite intergovernmental organizations specialized in the field of marks, of which at least one of the member countries is party to this Agreement, to be represented by observers at meetings of the Committee of Experts.

(c) The Director General may, and, if requested by the Committee of Experts, shall, invite representatives of other intergovernmental and international non-governmental organizations to participate in discussions of interest to them.

(3) The Committee of Experts shall:

(i) make amendments and additions to the Classification of Figurative Elements;

(ii) address recommendations to the countries of the Special Union for the purpose of facilitating the use of the Classification of Figurative Elements and promoting its uniform application;

(iii) take all the other measures which, without entailing financial implications for the budget of the Special Union or for the Organization, contribute towards facilitating the application of the Classification of Figurative Elements by developing countries;

(iv) have the right to establish subcommittees and working groups.

(4) The Committee of Experts shall adopt its own rules of procedure. The latter shall provide for the possibility of participation in meetings of the subcommittees and working groups of the Committee of Experts by those intergovernmental organizations referred to in paragraph 2(b) which can make a substantial contribution to the development of the Classification of Figurative Elements.

(5) Proposals for amendments or additions to the Classification of Figurative Elements may be made by the competent Office of any country of the Special Union, the International Bureau, any intergovernmental organization represented in the Committee of Experts pursuant to paragraph 2(b) and any country or organization specially invited by the Committee of Experts to submit such proposals. The proposals shall be communicated to the International Bureau, which shall submit them to the members of the Committee of Experts and to the observers not later than two months before the session of the Committee of Experts at which the said proposals are to be considered.

(6) (a) Each country member of the Committee of Experts shall have one vote.

(b) The decisions of the Committee of Experts shall require a simple majority of the countries represented and voting.

(c) Any decision which is regarded by one-fifth of the countries represented and voting as giving rise to a modification of the basic structure of the Classification of Figurative Elements or as entailing a substantial amount of reclassification shall require a majority of three-fourths of the countries represented and voting.

(d) Abstentions shall not be considered as votes.

#### **Article 6**

##### **Notification, Entry Into Force and Publication of Amendments and Additions and of Other Decisions**

(1) Every decision of the Committee of Experts concerning the adoption of amendments and additions to the Classification of Figurative Elements, and the recommendations of the Committee of Experts, shall be notified by the International Bureau to the competent Offices of the countries of the Special Union. The amendments and additions shall enter into force six months after the date of dispatch of the notifications.

(2) The International Bureau shall incorporate in the Classification of Figurative Elements amendments and additions which have entered into force. Announcements of the amendments and additions shall be published in such periodicals as may be designated by the Assembly referred to in Article 7.

#### **Article 7**

##### **Assembly of the Special Union**

(1) (a) The Special Union shall have an Assembly consisting of the countries of the Special Union.

(b) The Government of each country of the Special Union shall be represented by one delegate, who may be assisted by alternate delegates, advisors and experts.

(c) Any intergovernmental organization referred to in Article 5(2)(b) may be represented by an observer in the meetings of the Assembly, and, if the Assembly so decides, in those of such committees or working groups as may have been established by the Assembly.

(d) The expenses of each delegation shall be borne by the Government which has appointed it.

(2) (a) Subject to the provisions of Article 5, the Assembly shall:

(i) deal with all matters concerning the maintenance and development of the Special Union and the implementation of this Agreement;

(ii) give directions to the International Bureau concerning the preparation for revision conferences;

(iii) review and approve the reports and activities of the Director General concerning the Special Union, and give him all necessary instructions concerning matters within the competence of the Special Union;

(iv) determine the program and adopt the biennial budget of the Special Union, and approve its final accounts;

(v) adopt the financial regulations of the Special Union;

(vi) decide on the establishment of official texts of the Classification of Figurative Elements in languages other than English and French;

(vii) establish such committees and working groups as it deems appropriate to achieve the objectives of the Special Union;

(viii) determine, subject to paragraph (1)(c), which countries not members of the Special Union and which intergovernmental and international non-governmental organizations shall be admitted as observers to its meetings, and to those of any committee or working group established by it;

(ix) take any other appropriate action designed to further the objectives of the Special Union;

(x) perform such other functions as are appropriate under this Agreement.

(b) With respect to matters which are of interest also to other Unions administered by the Organization, the Assembly shall make its decisions after having heard the advice of the Coordination Committee of the Organization.

(3) (a) Each country member of the Assembly shall have one vote.

(b) One-half of the countries members of the Assembly shall constitute a quorum.

(c) In the absence of the quorum, the Assembly may make decisions but, with the exception of decisions concerning its own procedure, all such decisions shall take effect only if the conditions set forth hereinafter are fulfilled. The International Bureau shall communicate the said decisions to the countries members of the Assembly which were not represented and shall invite them to express in writing their vote or abstention within a period of three months from the date of the communication. If, at the expiration of this period, the number of countries having thus expressed their vote or abstention attains the number of countries which was lacking for attaining the quorum in the session itself, such decisions shall take effect provided that at the same time the required majority still obtains.

(d) Subject to the provisions of Article 11(2), the decisions of the Assembly shall require two-thirds of the votes cast.

(e) Abstentions shall not be considered as votes.

(f) A delegate may represent, and vote in the name of, one country only.

(4) (a) The Assembly shall meet once in every second calendar year in ordinary session upon convocation by the Director General and, in the absence of exceptional circumstances, during the same period and at the same place as the General Assembly of the Organization.

(b) The Assembly shall meet in extraordinary session upon convocation by the Director General, at the request of one-fourth of the countries members of the Assembly.

(c) The agenda of each session shall be prepared by the Director General.

(5) The Assembly shall adopt its own rules of procedure.

**Article 8**

**International Bureau**

(1) (a) Administrative tasks concerning the Special Union shall be performed by the International Bureau.

(b) In particular, the International Bureau shall prepare the meetings and provide the secretariat of the Assembly, the Committee of Experts and such other committees or working groups as may have been established by the Assembly or the Committee of Experts.

(c) The Director General shall be the chief executive of the Special Union and shall represent the Special Union.

(2) The Director General and any staff member designated by him shall participate, without the right of vote, in all meetings of the Assembly, the Committee of Experts and such other committees or working groups as may have been established by the Assembly or the Committee of Experts. The Director General or a staff member designated by him shall be ex officio secretary of those bodies.

(3) (a) The International Bureau shall, in accordance with the directions of the Assembly, make the preparations for revision conferences.

(b) The International Bureau may consult with intergovernmental and international non-governmental organizations concerning preparations for revision conferences.

(c) The Director General and persons designated by him shall take part, without the right to vote, in the discussions at revision conferences.

(4) The International Bureau shall carry out any other tasks assigned to it.

**Article 9**

**Finances**

(1) (a) The Special Union shall have a budget.

(b) The budget of the Special Union shall include the income and expenses proper to the Special Union, its contribution to the budget of expenses common to the Unions administered by the Organization and, where applicable, the sum made available to the budget of the Conference of the Organization.

(c) Expenses not attributable exclusively to the Special Union but also to one or more other Unions administered by the Organization shall be considered as expenses common to the Unions. The share of the Special Union in such common expenses shall be in proportion to the interest the Special Union has in them.

(2) The budget of the Special Union shall be established with due regard to the requirements of coordination with the budgets of the other Unions administered by the Organization.

(3) The budget of the Special Union shall be financed from the following sources:

(i) contributions of the countries of the Special Union;

(ii) fees and charges due for services rendered by the International Bureau in relation to the Special Union;

(iii) sale of, or royalties on, the publications of the International Bureau concerning the Special Union;

(iv) gifts, bequests and subventions;

(v) rents, interests and other miscellaneous income.

(4) (a) For the purpose of establishing its contribution referred to in paragraph 3(i), each country of the Special Union shall belong to the same class as it belongs to in the Paris Union for the Protection of Industrial Property, and shall pay its annual contribution on the basis of the same number of units as is fixed for that class in that Union.

(b) The annual contribution of each country of the Special Union shall be an amount in the same proportion to the total sum to be contributed to the budget of the Special Union by all countries as the number of its units is to the total of the units of all contributing countries.

(c) Contributions shall become due on the first of January of each year.

(d) A country which is in arrears in the payment of its contributions may not exercise its right to vote in any organ of the Special Union if the amount of its arrears equals or exceeds the amount of the contributions due from it for the preceding two full years. However, any organ of the Special Union may allow such a country to continue to exercise its right to vote in that organ if, and as long as, it is satisfied that the delay in payment is due to exceptional and unavoidable circumstances.

(e) If the budget is not adopted before the beginning of a new financial period, it shall be at the same level as the budget of the previous year, as provided in the financial regulations.

(5) The amount of the fees and charges due for services rendered by the International Bureau in relation to the Special Union shall be established, and shall be reported to the Assembly, by the Director General.

(6) (a) The Special Union shall have a working capital fund which shall be constituted by a single payment made by each country of the Special Union. If the fund becomes insufficient, the Assembly shall decide to increase it.

(b) The amount of the initial payment of each country to the said fund or of its participation in the increase thereof shall be a proportion of the contribution of that country for the year in which the fund is established or the decision to increase it is made.

(c) The proportion and the terms of payment shall be fixed by the Assembly on the proposal of the Director General and after it has heard the advice of the Coordination Committee of the Organization.

(7) (a) In the headquarters agreement concluded with the country on the territory of which the Organization has its headquarters, it shall be provided that, whenever the working capital fund is insufficient, such country shall grant advances. The amount of those advances and the conditions on which they are granted shall be the subject of separate agreements, in each case, between such country and the Organization.

(b) The country referred to in subparagraph (a) and the Organization shall each have the right to denounce the obligation to grant advances, by written notification. Denunciation shall take effect three years after the end of the year in which it was notified.

(8) The auditing of the accounts shall be effected by one or more of the countries of the Special Union or by external auditors, as provided in the financial regulations. They shall be designated, with their agreement, by the Assembly.



**Article 10**

**Revision of the Agreement**

(1) This Agreement may be revised from time to time by a special conference of the countries of the Special Union.

(2) The convocation of any revision conference shall be decided by the Assembly.

(3) Articles 7, 8, 9 and 11 may be amended either by a revision conference or according to the provisions of Article 11.

**Article 11**

**Amendment of Certain Provisions of the Agreement**

(1) Proposals for the amendment of Articles 7, 8, 9 and of the present Article may be initiated by any country of the Special Union or by the Director General. Such proposals shall be communicated by the Director General to the countries of the Special Union at least six months in advance of their consideration by the Assembly.

(2) Amendments to the Articles referred to in paragraph (1) shall be adopted by the Assembly. Adoption shall require three-fourths of the votes cast, provided that any amendment to Article 7 and to the present paragraph shall require four-fifths of the votes cast.

(3) (a) Any amendment to the Articles referred to in paragraph (1) shall enter into force one month after written notifications of acceptance, effected in accordance with their respective constitutional processes, have been received by the Director General from three-fourths of the countries members of the Special Union at the time the amendment was adopted.

(b) Any amendment to the said Articles thus accepted shall bind all the countries which are members of the Special Union at the time the amendment enters into force, provided that any amendment increasing the financial obligations of countries of the Special Union shall bind only those countries which have notified their acceptance of such amendment.

(c) Any amendment accepted in accordance with the provisions of subparagraph (a) shall bind all countries which become members of the Special Union after the date on which the amendment entered into force in accordance with the provisions of subparagraph (a).

**Article 12**

**Becoming Party to the Agreement**

(1) Any country party to the Paris Convention for the Protection of Industrial Property may become party to this Agreement by:

- (i) signature followed by the deposit of an instrument of ratification, or
- (ii) deposit of an instrument of accession.

(2) Instruments of ratification or accession shall be deposited with the Director General.

(3) The provisions of Article 24 of the Stockholm Act of the Paris Convention for the Protection of Industrial Property shall apply to this Agreement.

(4) Paragraph (3) shall in no way be understood as implying the recognition or tacit acceptance by a country of the Special Union of the factual situation concerning a territory to which this Agreement is made applicable by another country by virtue of the said paragraph.

**Article 13**

**Entry Into Force of the Agreement**

(1) With respect to the first five countries which have deposited their instruments of ratification or accession, this Agreement shall enter into force three months after the fifth instrument of ratification or accession has been deposited.

(2) With respect to any country other than those for which this Agreement has entered into force in accordance with paragraph (1), it shall enter into force three months after the date on which its ratification or accession was notified by the Director General, unless a subsequent date has been indicated in the instrument of ratification or accession. In the latter case, this Agreement shall enter into force with respect to that country on the date thus indicated.

(3) Ratification or accession shall automatically entail acceptance of all the clauses and admission to all the advantages of this Agreement.

**Article 14**

**Duration of the Agreement**

This Agreement shall have the same duration as the Paris Convention for the Protection of Industrial Property.

**Article 15**

**Denunciation**

(1) Any country of the Special Union may denounce this Agreement by notification addressed to the Director General.

(2) Denunciation shall take effect one year after the day on which the Director General has received the notification.

(3) The right of denunciation provided by this Article shall not be exercised by any country before the expiration of five years from the date upon which it becomes a member of the Special Union.

**Article 16**

**Disputes**

(1) Any dispute between two or more countries of the Special Union concerning the interpretation or application of this Agreement, not settled by negotiation, may, by any one of the countries concerned, be brought before the International Court of Justice by application in conformity with the Statute of the Court, unless the countries concerned agree on some other method of settlement. The country bringing the dispute before the Court shall inform the International Bureau; the International Bureau shall bring the matter to the attention of the other countries of the Special Union.

(2) Each country may, at the time it signs this Agreement or deposits its instrument of ratification or accession, declare that it does not consider itself bound by the provisions of paragraph (1). With regard to any dispute between any country having made such a declaration and any other country of the Special Union, the provisions of paragraph (1) shall not apply.

(3) Any country having made a declaration in accordance with the provisions of paragraph (2) may, at any time, withdraw its declaration by notification addressed to the Director General.

**Article 17**

**Signature, Languages, Depositary Functions, Notifications**

(1) (a) This Agreement shall be signed in a single original in the English and French languages, both texts being equally authentic.

(b) This Agreement shall remain open for signature at Vienna until December 31, 1973.

(c) The original of this Agreement, when no longer open for signature, shall be deposited with the Director General.

(2) Official texts shall be established by the Director General, after consultation with the interested Governments, in such other languages as the Assembly may designate.

(3) (a) The Director General shall transmit two copies, certified by him, of the signed text of this Agreement to the Governments of the countries that have signed it and, on request, to the Government of any other country.

(b) The Director General shall transmit two copies, certified by him, of any amendment to this Agreement to the Governments of all countries of the Special Union and, on request, to the Government of any other country.

(c) The Director General shall, on request, furnish the Government of any country that has signed this Agreement, or that accedes to it, with two copies of the Classification of Figurative Elements, certified by him, in the English or French language.

(4) The Director General shall register this Agreement with the Secretariat of the United Nations.

(5) The Director General shall notify the Governments of all countries party to the Paris Convention for the Protection of Industrial Property of:

- (i) signature under paragraph (1);
- (ii) deposits of instruments of ratification or accession under Article 12(2);
- (iii) the date of entry into force of this Agreement under Article 13(1);
- (iv) declarations made under Article 4(5);
- (v) declarations and notifications made in accordance with Article 12(3);
- (vi) declarations made under Article 16(2);
- (vii) withdrawals of any declarations, notified under Article 16(3);
- (viii) acceptances of amendments to this Agreement under Article 11(3);
- (ix) the dates on which such amendments enter into force;
- (x) denunciations received under Article 15.

## **Resolution**

adopted by the Diplomatic Conference  
on the International Classification  
of the Figurative Elements of Marks on June 8, 1973

1. Pending the entry into force of the Vienna Agreement Establishing an International Classification of the Figurative Elements of Marks, a provisional Committee of Experts is hereby set up at the International Bureau of the World Intellectual Property Organization (WIPO).

2. The provisional Committee shall include a representative of each country having signed or acceded to the said Agreement. Intergovernmental organizations specialized in the field of marks, of which at least one of the member countries has signed or acceded to the Agreement, may be represented by observers. Any country member of WIPO or party to the Paris Convention for the Protection of Industrial Property which has neither signed nor acceded to the Agreement may, and, if requested by the provisional Committee, shall, be invited by the Director General of WIPO to be represented by observers.

3. The provisional Committee shall reexamine the International Classification of the Figurative Elements of Marks and shall prepare, if necessary, draft amendments or additions to be made to the said Classification.

4. The International Bureau is invited to prepare the work of the provisional Committee.

5. The International Bureau is invited to convene the provisional Committee, after consultation of the countries which have signed or acceded to the Agreement, if amendments or additions are proposed by any such country or by an organization referred to in paragraph 2 above, or if the International Bureau itself intends to propose amendments or additions.

6. The International Bureau is invited to transmit, as soon as the Agreement enters into force, any draft amendments or additions prepared by the provisional Committee to the Committee of Experts set up under Article 5 of the Agreement.

7. The travel and subsistence expenses of members of the provisional Committee and of observers shall be borne by the countries or organizations which they represent.

## Recommendations concerning the application of the Classification

The Committee of Experts set up under Article 5 of the Vienna Agreement recommended, at its meetings on May 13, 1987, and on June 24, 1992, to the member countries of the Vienna Union that they apply, in their official documents and publications relating to registrations and renewals of marks, the International Classification of the Figurative Elements of Marks in the following manner:

(a) The numbers of the category and division, and of the division and sections should be separated by a point, and the numbers of two sections by a dash (e.g., Category 3, Division 9, Sections 10, 24 and 25 should be written as follows: CFE 3.9.10-24-25);\* if the numbers of the sections are not included in the classification, the numbers of categories and divisions should still be separated by a point (e.g., Category 3, Division 9 should be written as follows: CFE 3.9).

(b) If the numbers of several categories and divisions are necessary for the classification of one and the same registration, the classification for every category and division should be indicated separately, in numerical order; the various indications should be separated by a semicolon (e.g., CFE 1.1.2-10-25; 1.15.17; 2.9.1 or, if the section numbers are not included in the classification: CFE 1.1; 1.15; 2.9).

(c) The edition of the Vienna Classification according to which figurative elements of marks are classified should be indicated by an Arabic numeral in round brackets, for example, CFE (3).

---

\* The Committee of Experts, at its session in May 1987, determined that the abbreviation referred to in Article 4(4) of the Vienna Agreement, which is to precede the classification numbers where a country chooses to use an abbreviation instead of the words "Classification of Figurative Elements," is to be CFE.



**INTERNATIONAL CLASSIFICATION  
OF THE FIGURATIVE ELEMENTS OF MARKS**





## GUIDANCE FOR THE USER

In accordance with Article 4(1) of the Vienna Agreement, the scope of the International Classification of the Figurative Elements of Marks (hereinafter referred to as "the Classification") is that attributed to it by each country of the Vienna Union. Its main purpose, however, is in all cases to facilitate anticipation searching. For that searching to be effective, the following two operations have first to be completed:

- (i) consistent and correct classification (coding) of the figurative elements of the marks that are to constitute the search file, due account being taken of the future needs of anticipation searching;
- (ii) correct definition of the sections in which the prior marks have to be searched, due account being taken of the specific characteristics of coding.

The two operations are thus interdependent, and responsibility for them must be entrusted to persons with proven skills in the trademark field. Those persons should among other things be able to assess the figurative elements of marks according to their distinguishing properties.

Before starting to use the Classification, it is essential that the user familiarize himself, in this publication, with the Preface (pages 5 to 7), the Recommendations of the Committee of Experts (page 21) and the General Notes (page 36).

When using the Classification, the user should abide strictly by the explanatory notes and the references given in them.

The Classification itself is reproduced under the following three headings:

- (1) the Table of Categories (page 24), which affords rapid guidance as to the categories available in the Classification;
- (2) the Table of Categories and Divisions, with Explanatory Notes (pages 25 to 33), which gives an outline of the divisions available in a given category and makes it possible to confine the subject matter to the division that seems the most appropriate;
- (3) the List of Categories, Divisions and Sections, with Explanatory Notes (pages 35 to 82), which, with the aid of the complete information given by the explanatory notes on the categories, divisions and sections, makes it possible to decide finally where the figurative element concerned is classified.

The explanatory notes on a category apply also to all its divisions, even if they are not repeated every time.

The divisions are reproduced in the order of their categories, each division being followed by the sections relating to it.

Sections with a letter A before their numerical code are auxiliary sections, which group figurative elements contained in the main sections according to specific criteria. The letter A should not however appear in the numerical code assigned to the figurative element of a mark at the time of coding.

The examples of figurative elements reproduced on pages 83 to 102 are given for information purposes only, and therefore do not form an integral part of the Classification.

## TABLE OF CATEGORIES

- CATEGORY 1 Celestial bodies, natural phenomena, geographical maps
- CATEGORY 2 Human beings
- CATEGORY 3 Animals
- CATEGORY 4 Supernatural, fabulous, fantastic or unidentifiable beings
- CATEGORY 5 Plants
- CATEGORY 6 Landscapes
- CATEGORY 7 Constructions, structures for advertisements, gates or barriers
- CATEGORY 8 Foodstuffs
- CATEGORY 9 Textiles, clothing, sewing accessories, headwear, footwear
- CATEGORY 10 Tobacco, smokers' requisites, matches, travel goods, fans, toilet articles
- CATEGORY 11 Household utensils
- CATEGORY 12 Furniture, sanitary installations
- CATEGORY 13 Lighting, wireless valves, heating, cooking or refrigerating equipment, washing machines, drying equipment
- CATEGORY 14 Ironmongery, tools, ladders
- CATEGORY 15 Machinery, motors, engines
- CATEGORY 16 Telecommunications, sound recording or reproduction, computers, photography, cinematography, optics
- CATEGORY 17 Horological instruments, jewelry, weights and measures
- CATEGORY 18 Transport, equipment for animals
- CATEGORY 19 Containers and packing, representations of miscellaneous products
- CATEGORY 20 Writing, drawing or painting materials, office requisites, stationery and booksellers' goods
- CATEGORY 21 Games, toys, sporting articles, roundabouts
- CATEGORY 22 Musical instruments and their accessories, music accessories, bells, pictures, sculptures
- CATEGORY 23 Arms, ammunition, armour
- CATEGORY 24 Heraldry, coins, emblems, symbols
- CATEGORY 25 Ornamental motifs, surfaces or backgrounds with ornaments
- CATEGORY 26 Geometrical figures and solids
- CATEGORY 27 Forms of writing, numerals
- CATEGORY 28 Inscriptions in various characters
- CATEGORY 29 Colours

TABLE OF CATEGORIES AND DIVISIONS, WITH EXPLANATORY NOTES

**Category 1. CELESTIAL BODIES, NATURAL PHENOMENA, GEOGRAPHICAL MAPS**

1.1 STARS, COMETS

Note: (a) Including stars which indicate military rank.  
(b) Not including sparks (1.15.7) and asterisks (24.17.3).

1.3 SUN

Note: Not including representations of the sun consisting solely of a disk without rays, which will be placed in the appropriate sections of division 26.1.

1.5 EARTH, TERRESTRIAL GLOBES, PLANETS

1.7 MOON

Note: Including representations of the moon with star(s).

1.11 CONSTELLATIONS, GROUPS OF STARS, STARRY SKY, CELESTIAL GLOBES, CELESTIAL MAPS

1.13 ARMILLARY SPHERES, PLANETARIA, ASTRONOMIC ORBITS, ATOMIC MODELS, MOLECULAR MODELS

1.15 NATURAL PHENOMENA

1.17 GEOGRAPHICAL MAPS, PLANISPHERES

Note: Not including maps of the world in two hemispheres (1.5.1 and A 1.5.4).

**Category 2. HUMAN BEINGS**

Note: (a) Inscriptions representing a human being will be placed in 27.3.1.  
(b) Heads will be placed in the appropriate sections of divisions 2.1, 2.3, 2.5 or 2.7, and not in 2.9.25.

2.1 MEN

2.3 WOMEN

2.5 CHILDREN

Note: Not including adolescents, classified in divisions 2.1, 2.3 or 2.7.

2.7 MIXED GROUPS, SCENES

Note: (a) A mixed group means a group of men, women and/or children. A group composed of men, of women or of children will be placed in the appropriate sections of divisions 2.1, 2.3 or 2.5.  
(b) However, any group, whatever its composition, which gives the impression of a scene will be placed in the appropriate sections of division 2.7.

2.9 PARTS OF THE HUMAN BODY, SKELETONS, SKULLS

**Category 3. ANIMALS**

Note: (a) Heads of quadrupeds and of quadrumana will be placed in the appropriate sections of divisions 3.1 to 3.5 and not in 3.6.25.  
 (b) Written or typographical matter representing an animal is classified under 27.3.3.

- 3.1 QUADRUPEDS (SERIES I)
  - 3.2 QUADRUPEDS (SERIES II)
  - 3.3 QUADRUPEDS (SERIES III)
  - 3.4 QUADRUPEDS (SERIES IV)
  - 3.5 QUADRUPEDS (SERIES V), QUADRUMANA
  - 3.6 PARTS OF THE BODIES, SKELETONS, SKULLS OF QUADRUPEDS OR OF QUADRUMANA
  - 3.7 BIRDS, BATS
  - 3.9 AQUATIC ANIMALS, SCORPIONS
- Note: Not including aquatic animals of divisions 3.7, 3.11 or 3.13.
- 3.11 REPTILES, AMPHIBIA, SNAILS, SEALS, SEA LIONS
  - 3.13 INSECTS, SPIDERS, MICRO-ORGANISMS
  - 3.15 OTHER ANIMALS; LARGE PRE-HISTORIC ANIMALS
- Note: Not including fabulous animals of divisions 4.3 and 4.7.
- 3.17 GROUPS OF ANIMALS CLASSIFIED IN DIFFERENT DIVISIONS OF CATEGORY 3

**Category 4. SUPERNATURAL, FABULOUS, FANTASTIC OR UNIDENTIFIABLE BEINGS**

Note: Not including human beings and fantastic animals composed of letters or figures and classified in the appropriate sections of division 27.3.

- 4.1 WINGED OR HORNED PERSONAGES
- 4.2 BEINGS PARTLY HUMAN AND PARTLY ANIMAL
- 4.3 FABULOUS ANIMALS
- 4.5 PLANTS, OBJECTS OR GEOMETRICAL FIGURES REPRESENTING A PERSONAGE OR AN ANIMAL; MASKS OR FANTASTIC OR UNIDENTIFIABLE HEADS
- 4.7 GROUPS OF FIGURATIVE ELEMENTS CLASSIFIED IN DIFFERENT DIVISIONS OF CATEGORY 4

- Category 5. PLANTS**
- 5.1 TREES, BUSHES
  - 5.3 LEAVES, NEEDLES, BRANCHES WITH LEAVES OR NEEDLES
  - 5.5 FLOWERS, BLOSSOMS
  - Note: Including heraldic flowers.
  - 5.7 GRAIN, SEEDS, FRUITS
  - 5.9 VEGETABLES
  - 5.11 OTHER PLANTS
  - 5.13 DECORATIONS MADE OF PLANTS
- Category 6. LANDSCAPES**
- 6.1 MOUNTAINS, ROCKS, GROTTOS
  - 6.3 LANDSCAPES WITH WATER, RIVER OR STREAM
  - Note: Not including urban landscapes or village scenes with water, river or stream (6.7.11).
  - 6.6 DESERT OR TROPICAL-TYPE LANDSCAPES
  - 6.7 URBAN LANDSCAPES OR VILLAGE SCENES
  - 6.19 OTHER LANDSCAPES
- Category 7. CONSTRUCTIONS, STRUCTURES FOR ADVERTISEMENTS, GATES OR BARRIERS**
- 7.1 DWELLINGS, BUILDINGS, ADVERTISEMENT HOARDINGS OR PILLARS, CAGES OR KENNELS FOR ANIMALS
  - 7.3 PARTS OF DWELLINGS OR OF BUILDINGS, INTERIORS
  - 7.5 MONUMENTS, STADIUMS, FOUNTAINS
  - 7.11 STRUCTURAL WORKS
  - 7.15 BUILDING MATERIALS, WALLS, GATES OR BARRIERS, SCAFFOLDING
- Category 8. FOODSTUFFS**
- 8.1 BAKERS' PRODUCTS, PASTRY, CONFECTIONERY, CHOCOLATE
  - 8.3 MILK, DAIRY PRODUCTS, CHEESES
  - 8.5 BUTCHERS' MEAT, PORK PRODUCTS, FISHMONGERS' PRODUCTS
  - 8.7 OTHER FOODSTUFFS

TABLE OF CATEGORIES AND DIVISIONS, WITH EXPLANATORY NOTES

---

- Category 9. TEXTILES, CLOTHING, SEWING ACCESSORIES, HEADWEAR, FOOTWEAR**
- 9.1 TEXTILES OTHER THAN CLOTHING, SHUTTLES
  - 9.3 CLOTHING  
Note: Not including headwear (9.7) and footwear (9.9).
  - 9.5 SEWING ACCESSORIES, PATTERNS FOR DRESSMAKING
  - 9.7 HEADWEAR
  - 9.9 FOOTWEAR
- Category 10. TOBACCO, SMOKERS' REQUISITES, MATCHES, TRAVEL GOODS, FANS, TOILET ARTICLES**
- 10.1 TOBACCO, SMOKERS' REQUISITES, MATCHES
  - 10.3 TRAVEL GOODS, FANS, BAGS
  - 10.5 TOILET ARTICLES, MIRRORS
- Category 11. HOUSEHOLD UTENSILS**
- Note: Not including household utensils classified in categories 12, 13 or 19.
- 11.1 KNIVES, FORKS AND SPOONS, KITCHEN UTENSILS AND MACHINES
  - 11.3 CONTAINERS FOR BEVERAGES, PLATES AND DISHES, KITCHEN UTENSILS FOR SERVING, PREPARING OR COOKING FOOD OR DRINK  
Note: Not including kitchen utensils classified in 11.1.
  - 11.7 OTHER HOUSEHOLD UTENSILS
- Category 12. FURNITURE, SANITARY INSTALLATIONS**
- 12.1 FURNITURE  
Note: Including office furniture.
  - 12.3 SANITARY INSTALLATIONS
- Category 13. LIGHTING, WIRELESS VALVES, HEATING, COOKING OR REFRIGERATING EQUIPMENT, WASHING MACHINES, DRYING EQUIPMENT**
- 13.1 LIGHTING, WIRELESS VALVES
  - 13.3 HEATING, COOKING OR REFRIGERATING EQUIPMENT, WASHING MACHINES, DRYING EQUIPMENT

- Category 14. IRONMONGERY, TOOLS, LADDERS**
- 14.1 TUBES, CABLES, HEAVY IRONMONGERY ARTICLES  
Note: Including representations of non-metallic ironmongery articles.
  - 14.3 SMALL IRONMONGERY ARTICLES, SPRINGS
  - 14.5 KEYS FOR LOCKS, LOCKS, PADLOCKS
  - 14.7 TOOLS  
Note: Not including agricultural or horticultural implements classified in division 14.9.
  - 14.9 AGRICULTURAL OR HORTICULTURAL IMPLEMENTS, ICE AXES
  - 14.11 LADDERS

- Category 15. MACHINERY, MOTORS, ENGINES**
- 15.1 MACHINES FOR INDUSTRY OR AGRICULTURE, INDUSTRIAL INSTALLATIONS, MOTORS, ENGINES, VARIOUS MECHANICAL APPLIANCES  
Note: Not including machines for household use and spinning wheels (15.3) or office machines (15.5).
  - 15.3 MACHINES FOR HOUSEHOLD USE, SPINNING WHEELS
  - 15.5 OFFICE MACHINES
  - 15.7 WHEELS, BEARINGS
  - 15.9 ELECTRICAL EQUIPMENT  
Note: Not including electric lamps and wireless valves (13.1.6, A 13.1.17 and A 13.1.18) or electric cables (14.1.5).

- Category 16. TELECOMMUNICATIONS, SOUND RECORDING OR REPRODUCTION, COMPUTERS, PHOTOGRAPHY, CINEMATOGRAPHY, OPTICS**
- 16.1 TELECOMMUNICATIONS, SOUND RECORDING OR REPRODUCTION, COMPUTERS
  - 16.3 PHOTOGRAPHY, CINEMATOGRAPHY, OPTICS

- Category 17. HOROLOGICAL INSTRUMENTS, JEWELRY, WEIGHTS AND MEASURES**
- 17.1 HOROLOGICAL AND OTHER TIME-MEASURING INSTRUMENTS
  - 17.2 JEWELRY
  - 17.3 BALANCES, WEIGHTS
  - 17.5 MEASURES  
Note: Including calculating instruments.



**Category 18. TRANSPORT, EQUIPMENT FOR ANIMALS**

- 18.1 LAND VEHICLES
- 18.2 EQUIPMENT FOR ANIMALS
- 18.3 VEHICLES FOR USE ON WATER AND AMPHIBIOUS VEHICLES
- 18.4 ANCHORS, BUOYS, LIFE BELTS
- 18.5 AERIAL OR SPACE VEHICLES
- 18.7 TRAFFIC SIGNS

**Category 19. CONTAINERS AND PACKING, REPRESENTATIONS OF MISCELLANEOUS PRODUCTS**

- 19.1 LARGE CONTAINERS  
Note: Not including containers classified in 19.9.
- 19.3. SMALL CONTAINERS  
Note: Not including containers classified in 11.3, 19.7, 19.9 or 19.11.
- 19.7 BOTTLES, FLASKS
- 19.8 PARTS OR ACCESSORIES OF BOTTLES
- 19.9 AMPHORAE, PITCHERS, VASES, FLOWER POTS, FLOWER STANDS
- 19.11 RECEPTACLES FOR LABORATORY USE AND FOR PHARMACY
- 19.13 MEDICAL OR SURGICAL APPARATUS, INSTRUMENTS OR UTENSILS, PROSTHESES, MEDICINES
- 19.19 REPRESENTATIONS OF MISCELLANEOUS PRODUCTS  
Note: Includes all representations of products not classified in other categories, divisions and sections.

**Category 20. WRITING, DRAWING OR PAINTING MATERIALS, OFFICE REQUISITES, STATIONERY AND BOOKSELLERS' GOODS**

- 20.1 WRITING, DRAWING OR PAINTING MATERIALS, SMALL OFFICE REQUISITES
- 20.5 PAPERS, DOCUMENTS
- 20.7 BOOKS, BOOKBINDINGS, NEWSPAPERS

**Category 21. GAMES, TOYS, SPORTING ARTICLES, ROUNDABOUTS**

- 21.1 GAMES, TOYS
- 21.3 SPORTING ARTICLES, ROUNDABOUTS

**Category 22. MUSICAL INSTRUMENTS AND THEIR ACCESSORIES, MUSIC ACCESSORIES, BELLS, PICTURES, SCULPTURES**

- 22.1 MUSICAL INSTRUMENTS, MUSICAL INSTRUMENT ACCESSORIES, MUSIC ACCESSORIES
- 22.3 BELLS
- 22.5 PICTURES, SCULPTURES

**Category 23. ARMS, AMMUNITION, ARMOUR**

Note: Not including military tanks (18.1.14), military aircraft (18.5.1) and warships, which are classified in division 18.3.

- 23.1 SIDE ARMS, OTHER WEAPONS NOT BEING FIREARMS
- 23.3 FIREARMS, AMMUNITION, EXPLOSIVES
- 23.5 ARMOUR

**Category 24. HERALDRY, COINS, EMBLEMS, SYMBOLS**

- 24.1 SHIELDS
- 24.3 SEALS, STAMPS
- 24.5 MEDALS, COINS, DECORATIONS, ORDERS
- 24.7 FLAGS
- 24.9 CROWNS, DIADEMS
- 24.11 EMBLEMS, INSIGNIA
- 24.13 CROSSES
- 24.15 ARROWS
- 24.17 SIGNS, NOTATIONS, SYMBOLS

**Category 25. ORNAMENTAL MOTIFS, SURFACES OR BACKGROUNDS WITH ORNAMENTS**

- 25.1 ORNAMENTAL MOTIFS

Note: Not including ornamental motifs composed of plants, which are classified in division 5.13, or horizontally elongated ornamental surfaces, which are classified in division 25.3.

- 25.3 HORIZONTALLY ELONGATED ORNAMENTAL SURFACES

Note: Not including elongated elliptical surfaces, which are classified in division 26.1, elongated triangular surfaces, which are classified in division 26.3, or elongated quadrilateral surfaces, which are classified in division 26.4.

- 25.5 BACKGROUNDS DIVIDED INTO TWO OR FOUR  
Note: Includes backgrounds divided into two or four by lines or bands or by areas of different appearance.
- 25.7 SURFACES OR BACKGROUNDS COVERED WITH REPEATED FIGURATIVE ELEMENTS OR INSCRIPTIONS
- 25.12 SURFACES OR BACKGROUNDS COVERED WITH OTHER ORNAMENTS

**Category 26. GEOMETRICAL FIGURES AND SOLIDS**

- Note: (a) Including geometrical figures and solids composed of human beings, animals, plants or objects.  
 (b) Not including inscriptions forming geometrical figures, which are classified in division 27.1.
- 26.1 CIRCLES, ELLIPSES
- 26.2 SEGMENTS OR SECTORS OF CIRCLES OR ELLIPSES
- 26.3 TRIANGLES, LINES FORMING AN ANGLE
- 26.4 QUADRILATERALS
- 26.5 OTHER POLYGONS  
Note: Not including elongated polygons (25.3.1 and A 25.3.9).
- 26.7 DIFFERENT GEOMETRICAL FIGURES, JUXTAPOSED, JOINED OR INTERSECTING
- 26.11 LINES, BANDS  
Note: Not including lines or bands forming an angle (26.3.23).
- 26.13 OTHER GEOMETRICAL FIGURES, INDEFINABLE DESIGNS
- 26.15 GEOMETRICAL SOLIDS

**Category 27. FORMS OF WRITING, NUMERALS**

- 27.1 LETTERS OR NUMERALS FORMING GEOMETRICAL FIGURES, WRITTEN OR TYPOGRAPHICAL MATTER IN PERSPECTIVE  
Note: Includes both a single letter or a single numeral and a group of letters or a group of numerals.
- 27.3 LETTERS OR NUMERALS REPRESENTING A HUMAN BEING, AN ANIMAL, A PLANT OR AN OBJECT  
Note: (a) Includes also punctuation marks representing a human being, an animal, a plant or an object.  
 (b) Includes both a single letter, a single numeral or a single punctuation mark and a group of letters, a group of numerals or a group of punctuation marks representing a human being, an animal, a plant or an object.
- 27.5 LETTERS PRESENTING A SPECIAL FORM OF WRITING  
Note: Includes both one or more letters and a series of letters forming a word.
- 27.7 NUMERALS PRESENTING A SPECIAL FORM OF WRITING

**Category 28. INSCRIPTIONS IN VARIOUS CHARACTERS**

Note: Naturally, no account should be taken, in a given country, of the divisions relating to inscriptions in characters normally used in that country. In such cases, the inscriptions constitute word marks.

- 28.1 INSCRIPTIONS IN ARABIC CHARACTERS
- 28.3 INSCRIPTIONS IN CHINESE OR JAPANESE CHARACTERS
- 28.5 INSCRIPTIONS IN CYRILLIC CHARACTERS
- 28.7 INSCRIPTIONS IN GREEK CHARACTERS
- 28.9 INSCRIPTIONS IN HEBREW CHARACTERS
- 28.11 INSCRIPTIONS IN LATIN CHARACTERS
- 28.17 INSCRIPTIONS IN HISTORICAL CHARACTERS
- 28.19 INSCRIPTIONS IN OTHER CHARACTERS

**Category 29. COLOURS**

- 29.1 COLOURS



**LIST OF CATEGORIES, DIVISIONS AND SECTIONS, WITH EXPLANATORY NOTES**

GENERAL NOTES  
=====

(a) Figurative elements should be placed in the different categories, divisions and sections on the basis of their shape, regardless of their material composition or the purpose of the object in which they are incorporated. Consequently, toys in the form of dolls, animals and vehicles are placed in the categories for human beings, animals and vehicles, respectively. Similarly, persons, animals or objects of any kind represented in pictures or sculptures, for instance, are placed in the categories for human beings, animals, or the objects concerned. If the pictures or sculptures are widely known and famous, they should also be placed in the division provided for that purpose (division 22.5).

(b) The representation of an object forming part of another object should be classified under the same category, division and section as the object of which it forms part, unless expressly classified in another category, division and section. Thus, the bodywork of a motor vehicle is placed in sections 18.1.7 and A 18.1.9, as are motor vehicles, whereas the tyres, wheels or steering wheel of such a vehicle are placed in section 18.1.21, expressly intended for these parts of motor vehicles.

(c) If a figurative element is presented in such a way that it is not possible to determine clearly whether it belongs to a given division or section, it should be placed in both divisions or sections, unless there is a special note to the contrary. If, for example, the representation of a human being is not such that it can be clearly determined whether it is a man or a woman, it is placed in both of the divisions 2.1 and 2.3.

(d) The representation of an object or of a living creature similar to that of an object or of a living creature mentioned in the text of a given section is placed in that section even if it is not expressly mentioned there or in any other section.

(e) It is understood that, if a mark comprises several figurative elements, each of which having its own distinctive characteristic and being classified in a different category, division and section, these figurative elements should be placed in the appropriate different categories, divisions and sections. Thus, the label of a bottle comprising the representation of a castle and a characteristic form of writing is placed in the appropriate divisions and sections of categories 7 and 27; in the same way, the representation of a man in uniform, on horseback and playing a trumpet, is placed in the three sections 2.1.2, 2.1.20 and 2.1.9.

1. CELESTIAL BODIES, NATURAL PHENOMENA, GEOGRAPHICAL MAPS

1.1 STARS, COMETS

1.3 SUN

1.5 EARTH, TERRESTRIAL GLOBES, PLANETS

1.7 MOON

1.11 CONSTELLATIONS, GROUPS OF STARS, STARRY SKY, CELESTIAL GLOBES, CELESTIAL MAPS

1.13 ARMILLARY SPHERES, PLANETARIA, ASTRONOMIC ORBITS, ATOMIC MODELS, MOLECULAR MODELS

1.15 NATURAL PHENOMENA

1.17 GEOGRAPHICAL MAPS, PLANISPHERES

1.1 STARS, COMETS

Note: (a) Including stars which indicate military rank.  
(b) Not including sparks (1.15.7) and asterisks (24.17.3).

1.1.1 Stars  
A 1.1.2 One star  
A 1.1.3 Two stars  
A 1.1.4 Three stars  
A 1.1.5 More than three stars  
Note: Not including constellations and groups of stars of division 1.11.

A 1.1.8 Stars with three points  
A 1.1.9 Stars with four points  
A 1.1.10 Stars with more than four points

A 1.1.12 Stars with uneven points  
Note: Including sparks consisting of uneven-pointed stars.

A 1.1.13 Stars with rays or radiating lines

1.1.15 Comets, stars with tail

1.1.17 Compass cards  
Note: Not including compasses, mariners' compasses (17.5.1 and A 17.5.21).

A 1.1.25 Other representations of stars, not classified in division 1.11

1.3 SUN

Note: Not including representations of the sun consisting solely of a disk without rays, which will be placed in the appropriate sections of division 26.1.

1.3.1 Sun rising or setting  
1.3.2 Other representations of the sun

A 1.3.6 Sun with landscapes  
A 1.3.7 Sun with human beings or parts of the human body

A 1.3.8 Sun with animals  
A 1.3.9 Sun with plants  
A 1.3.10 Sun with clouds, rain, drops of water or representations of other natural phenomena

A 1.3.11 Sun with manufactured articles or industrial products  
A 1.3.12 Sun with other figurative elements  
A 1.3.13 Sun with inscriptions

A 1.3.15 Sun with rays constituted by rectilinear lines, sheaves of lines or bands

A 1.3.16 Sun with rays constituted by flames or wavy lines, sheaves of lines or bands

A 1.3.17 Sun with rays constituted by triangles  
A 1.3.18 Sun with irregular rays (corona)  
1.3.19 Several suns

Note: Not including several suns forming a constellation (1.11).  
A 1.3.20 Sun representing a human face or the head of an animal



LIST OF CATEGORIES, DIVISIONS AND SECTIONS, WITH EXPLANATORY NOTES

1.5	EARTH, TERRESTRIAL GLOBES, PLANETS	A 1.11.3	Southern Cross
		A 1.11.4	Great Bear, Little Bear
1.5.1	Terrestrial globes		
A 1.5.2	Terrestrial globes with representation solely of meridians and parallels	A 1.11.8	Stars grouped in circles, ovals or other geometrical figures
A 1.5.3	Terrestrial globes in flattened form	A 1.11.9	Milky Way, galaxies
A 1.5.4	Two terrestrial globes, maps of the world in two hemispheres	A 1.11.10	Other constellations or groups of stars (except A 1.11.8)
A 1.5.5	Free-standing terrestrial globes		<u>Note:</u> Not including crescent or half-moon with star(s) (1.7.6 and A 1.7.9).
A 1.5.6	Terrestrial globes with a banderole or an inscription		
A 1.5.7	Terrestrial globes with human beings or parts of the human body	1.11.12	Starry sky
A 1.5.8	Terrestrial globes with animals		
A 1.5.9	Terrestrial globes with plants	1.11.15	Celestial globes, celestial maps
A 1.5.10	Terrestrial globes with clouds, rain, drops or water or representations of other natural phenomena		
A 1.5.11	Terrestrial globes with manufactured articles or industrial products		
A 1.5.12	Terrestrial globes with other figurative elements	1.13	ARMILLARY SPHERES, PLANETARIA, ASTRONOMIC ORBITS, ATOMIC MODELS, MOLECULAR MODELS
1.5.15	Parts of terrestrial globes	1.13.1	Armillary spheres, planetaria, astronomic orbits, atomic models, molecular models
A 1.5.23	Other representations of the Earth or of the terrestrial globe	A 1.13.2	Armillary spheres, planetaria
1.5.24	Saturn	A 1.13.5	Astronomic orbits
1.5.25	Other planets	A 1.13.10	Atomic orbits
		A 1.13.15	Atomic models, molecular models
1.7	MOON		
	<u>Note:</u> Including representations of the moon with star(s).		
1.7.1	Full moon, several moons	1.15	NATURAL PHENOMENA
A 1.7.3	Full moon representing a human face or the head of an animal	1.15.1	Rainbows
1.7.6	Crescent moon, half-moon	1.15.3	Lightning
A 1.7.7	Crescent or half-moon with human beings or parts of the human body	1.15.5	Flames
A 1.7.8	Crescent or half-moon with animals	1.15.7	Sparks, explosions, exploding fireworks
A 1.7.10	Crescent or half-moon with clouds, rain, drops of water or representations of other natural phenomena		<u>Note:</u> Not including sparks represented by uneven-pointed stars (1.11.1 and A 1.1.12).
A 1.7.11	Crescent or half-moon with manufactured articles or industrial products	1.15.9	Luminous sources, rays, shafts of light
A 1.7.12	Crescent or half-moon with other figurative elements	1.15.11	Clouds, fog, vapor, smoke
1.7.19	Several crescents or half-moons	1.15.13	Rain, hail
A 1.7.20	Crescent or half-moon representing a human face or the head of an animal	1.15.14	Puddles (of water)
		1.15.15	Drops
1.7.22	Lunar globe	1.15.17	Snow, snow flakes or snow crystals
		1.15.19	Icicles, stalactites, stalagmites, mineral crystals
		1.15.21	Bubbles, frothy masses
1.11	CONSTELLATIONS, GROUPS OF STARS, STARRY SKY, CELESTIAL GLOBES, CELESTIAL MAPS		
1.11.1	Constellations, galaxies		
A 1.11.2	Orion		

- 1.15.23 Vortices, rotary movements  
Note: Not including astronomic orbits (1.13.1 and A 1.13.5), atomic orbits (1.13.1 and A 1.13.10), concentric circles (26.1.4 or 26.1.5) and spirals (26.1.5).
- 1.15.24 Waves  
Note: Not including waves represented by wavy lines (26.11.1 to 26.11.3 and A 26.11.13).
- 1.15.25 Other natural phenomena not classified in other divisions or categories  
Note: Including aurora borealis (northern lights).
- 1.17 GEOGRAPHICAL MAPS, PLANISPHERES  
Note: Not including maps of the world in two hemispheres (1.5.1 and A 1.5.4).
- 1.17.1 Planispheres  
 1.17.2 Continents  
 A 1.17.3 Europe, Asia, Eurasia  
 A 1.17.4 America  
Note: Includes the whole of the continent of America (North, South and Central America) or any one or any two of the separate parts of the continent of America.
- A 1.17.5 Africa  
 A 1.17.6 Australia, Oceania  
 1.17.7 Groups of countries  
 . . . . .  
 1.17.11 Isolated countries  
 1.17.12 Islands, archipelagoes  
 1.17.13 Parts of a country  
 1.17.14 Urban plans  
 1.17.15 Polar maps  
 A 1.17.16 Physical maps  
 A 1.17.17 Political maps  
 A 1.17.18 Economic maps  
 A 1.17.19 Tourist maps  
 . . . . .  
 1.17.25 Other geographical maps

2. HUMAN BEINGS

Note: (a) Inscriptions representing a human being will be placed in 27.3.1.  
 (b) Heads will be placed in the appropriate sections of divisions 2.1, 2.3, 2.5 or 2.7, and not in 2.9.25.

- 2.1 MEN
- 2.3 WOMEN
- 2.5 CHILDREN
- 2.7 MIXED GROUPS, SCENES
- 2.9 PARTS OF THE HUMAN BODY, SKELETONS, SKULLS

- |          |  |          |  |
|----------|--|----------|--|
| 2.1      | MEN  | 2.3.5    | Nude women or women wearing underclothes, a bathing costume, or other light attire |
| 2.1.1    | Heads, busts   | A 2.3.6  | Women at their toilet  |
| 2.1.2    | Armed men or men wearing armour or a uniform   | 2.3.7    | Women wearing a long dress   |
| 2.1.3    | Religious figures, men wearing a robe or a toga  | 2.3.8    | Women engaging in sport, women dancers, drum majorettes                            |
| 2.1.4    | Men wearing folk or historical costume, cowboys  | 2.3.9    | Women wearing a kimono, a sari, a djellaba   |
| 2.1.5    | Men wearing a dinner jacket  | 2.3.10   | Women wearing trousers   |
| 2.1.7    | Harlequins, clowns, pierrots, carnival characters or grotesque or freakish figures, dwarfs                               | 2.3.11   | Women cooking or doing housework, waitresses                                       |
| 2.1.8    | Acrobats, athletes, dancers, jugglers, nude men, men practising sports (except 2.1.2, 2.1.12, 2.1.14, 2.1.20 and 2.1.21) | 2.3.12   | Women doing agricultural work  |
| 2.1.9    | Musicians, men with musical instruments  | 2.3.13   | Women sewing, spinning or knitting   |
| 2.1.11   | Butchers, chefs, waiters, pastrycooks  | 2.3.14   | Women with typewriters or doing other office work                                  |
| 2.1.12   | Sailors, seamen, fishermen   | 2.3.15   | Other professionals (women)<br><u>Note:</u> Including astronauts.                  |
| 2.1.14   | Divers, frogmen  | A 2.3.16 | Women in profile, women's silhouettes  |
| 2.1.15   | Other professionals (men)<br><u>Note:</u> Including astronauts.  | A 2.3.17 | Women seated or kneeling   |
| A 2.1.16 | Shadows or silhouettes of men  | A 2.3.18 | Women drinking or eating   |
| A 2.1.17 | Men seated or kneeling   | A 2.3.19 | Women smoking  |
| A 2.1.18 | Men drinking or eating   | 2.3.20   | Women mounted on or accompanied by a horse, a mule or a donkey                     |
| A 2.1.19 | Men smoking  | 2.3.21   | Women mounted on animals or accompanied by animals (except 2.3.20)                 |
| 2.1.20   | Men mounted on or accompanied by a horse, a mule or a donkey   | 2.3.22   | Allegorical or mythological female personages                                      |
| 2.1.21   | Men mounted on animals or accompanied by animals (except 2.1.20)   | A 2.3.23 | Women stylized   |
| 2.1.22   | Allegorical or mythological masculine personages   | A 2.3.24 | Several women  |
| A 2.1.23 | Men stylized   | 2.3.25   | Other women  |
| A 2.1.24 | Several men  |          |  |
| 2.1.25   | Other men  | 2.5      | CHILDREN   |
|          |  |          | <u>Note:</u> Not including adolescents, classified in divisions 2.1, 2.3 or 2.7.   |
|          |  | 2.5.1    | Heads, busts   |
|          |  | 2.5.2    | Boys   |
|          |  | 2.5.3    | Girls  |
|          |  | 2.5.4    | Children wearing folk, historical or cowboy costume                                |
| 2.3      | WOMEN  | 2.5.5    | Children in working costume or wearing a uniform                                   |
| 2.3.1    | Heads, busts   | 2.5.6    | Babies   |
| A 2.3.2  | Heads in silhouette, without facial detail   | ...      |  |
| 2.3.3    | Nuns, nurses   |          |  |
| 2.3.4    | Women wearing folk or historical costume   |          |  |

LIST OF CATEGORIES, DIVISIONS AND SECTIONS, WITH EXPLANATORY NOTES

2.5.8	Children engaging in sport or playing	2.7.21	Groups with animals (except 2.7.13, 2.7.14, 2.7.17 and 2.7.20)
A 2.5.17	Children seated, kneeling or on all fours	2.7.23	Groups stylized
A 2.5.18	Children drinking or eating	2.7.25	Other groups or scenes
A 2.5.19	Children crying		
2.5.21	Children with animals		
A 2.5.22	Pairs of children of different sexes	2.9	PARTS OF THE HUMAN BODY, SKELETONS, SKULLS
A 2.5.23	Children stylized		
A 2.5.24	Several children		
2.5.25	Other children		
2.7	MIXED GROUPS, SCENES	2.9.1	Hearts <u>Note:</u> Including also hearts represented as a symbol or on playing cards.
	<u>Note:</u> (a) A mixed group means a group of men, women and/or children. A group composed of men, of women or of children will be placed in the appropriate sections of divisions 2.1, 2.3 or 2.5.	2.9.4	Eyes <u>Note:</u> Including eyes with or without eyebrows.
	(b) However, any group, whatever its composition, which gives the impression of a scene will be placed in the appropriate sections of division 2.7.	2.9.6	Ears
		2.9.8	Lips
		2.9.10	Teeth, dentures
		2.9.12	Hair, locks of hair, wigs, beards, moustaches
2.7.1	Heads or busts of man and woman (couple)	2.9.14	Hands, fingers, imprints of hands or of fingers, arms
2.7.2	Man and woman (couple)	A 2.9.15	Open hands (palm or back)
2.7.4	Man and woman (couple wearing a folk or historical costume)	A 2.9.16	Hands joined in handshake
A 2.7.5	Man and woman (couple) nude or wearing underclothes or other light attire	A 2.9.17	Imprints of hands or of fingers
A 2.7.9	Woman (women) and baby (babies)	2.9.19	Feet, toes, imprints of feet or of toes, legs
2.7.10	Woman (women) and child (children)	2.9.21	Bodies or dummies without head or feet
2.7.11	Man (men) and child (children)	2.9.22	Skeletons, parts of skeletons, bones (except 2.9.23)
2.7.12	A man and a woman with child (children) (family)	2.9.23	Skulls
2.7.13	Group sporting scenes	2.9.25	Other parts of the human body
2.7.14	Groups of workers in fields or forests <u>Note:</u> Includes all groups of workers in the open air, engaged in agriculture, horticulture or forestry.		<u>Note:</u> Not including heads, which will be placed in the appropriate sections of divisions 2.1, 2.3, 2.5 or 2.7.
2.7.15	Other groups at work		
2.7.16	Theater, variety, concert or dancing scenes		
2.7.17	Travelling shows, fairs and fairgrounds, street scenes, groups with vehicle(s)		
2.7.18	Groups eating or drinking		
2.7.19	Indoor scenes, groups gathered around a table <u>Note:</u> Groups gathered around a table generally represent indoor scenes. However, they will be placed in this section in all cases, even if the group is out of doors.		
2.7.20	Battle scenes, military troops		

3. ANIMALS

Note: (a) Heads of quadrupeds and of quadrumana will be placed in the appropriate sections of divisions 3.1 to 3.5 and not in 3.6.25.

(b) Written or typographical matter representing an animal is classified under 27.3.3.

- 3.1 QUADRUPEDS (SERIES I)
- 3.2 QUADRUPEDS (SERIES II)
- 3.3 QUADRUPEDS (SERIES III)
- 3.4 QUADRUPEDS (SERIES IV)
- 3.5 QUADRUPEDS (SERIES V), QUADRUMANA
- 3.6 PARTS OF THE BODIES, SKELETONS, SKULLS OF QUADRUPEDS OR OF QUADRUMANA
- 3.7 BIRDS, BATS
- 3.9 AQUATIC ANIMALS, SCORPIONS
- 3.11 REPTILES, AMPHIBIA, SNAILS, SEALS, SEA LIONS
- 3.13 INSECTS, SPIDERS, MICRO-ORGANISMS
- 3.15 OTHER ANIMALS; LARGE PRE-HISTORIC ANIMALS
- 3.17 GROUPS OF ANIMALS CLASSIFIED IN DIFFERENT DIVISIONS OF CATEGORY 3

- |          |  |          |   |
|----------|--|----------|---|
| 3.1      | QUADRUPEDS (SERIES I)  | 3.2      | QUADRUPEDS (SERIES II)                  |
| 3.1.1    | Lions  | 3.2.1    | Elephants, mammoths                     |
| A 3.1.2  | Heraldic lions   | A 3.2.3  | Elephants or mammoths facing front      |
| 3.1.4    | Tigers or other large felines  | A 3.2.4  | Two elephants facing each other         |
| 3.1.6    | Cats or other small felines  | 3.2.7    | Hippopotamus, rhinoceros                |
| 3.1.8    | Dogs, wolves, foxes  | 3.2.9    | Giraffes                                |
| A 3.1.9  | Boxers, bulldogs   | 3.2.11   | Okapis                                  |
| A 3.1.10 | Saint Bernards   | 3.2.13   | Camels, dromedaries, llamas             |
| A 3.1.11 | Poodles  | 3.2.15   | Heads of animals of Series II           |
| 3.1.14   | Bears, pandas  | A 3.2.24 | Animals of Series II stylized           |
| 3.1.16   | Heads of animals of Series I   | A 3.2.25 | Animals of Series II in costume         |
| A 3.1.17 | Animals of Series I standing   | 3.3      | QUADRUPEDS (SERIES III)                 |
| 3.1.18   | Animals of Series I lying down   | 3.3.1    | Horses, mules                           |
| A 3.1.19 | Animals of Series I sitting down   | 3.3.2    | Donkeys                                 |
| A 3.1.20 | Animals of Series I rearing  | 3.3.3    | Zebbras                                 |
| A 3.1.21 | Animals of Series I bounding   | 3.3.15   | Heads of animals of Series III          |
| A 3.1.22 | Animals of Series I with forepaw(s) resting on an escutcheon or other object | A 3.3.17 | Animals of Series III rearing, bounding |
| A 3.1.23 | Animals of Series I facing each other  | A 3.3.24 | Animals of Series III stylized          |
| A 3.1.24 | Animals of Series I stylized   | A 3.3.25 | Animals of Series III in costume        |
| A 3.1.25 | Animals of Series I in costume   |          |   |

LIST OF CATEGORIES, DIVISIONS AND SECTIONS, WITH EXPLANATORY NOTES

3.4	QUADRUPEDS (SERIES IV)	A 3.6.11	Hides, skins
3.4.1	Bovines	A 3.6.25	Other parts of the bodies of quadrupeds or of quadrumana
A 3.4.2	Cows, calves		<u>Note:</u> Not including heads, which will be placed in the appropriate sections of divisions 3.1 to 3.5.
A 3.4.3	Cows with person milking them		
A 3.4.4	Bisons, bulls		
A 3.4.5	Other bovines		
3.4.7	Deer, stags, elk, reindeer, fawns, antelopes		
3.4.11	Goats, sheep	3.7	BIRDS, BATS
3.4.12	Heads of animals of Series IV, without horns (except 3.4.20)	3.7.1	Eagles, falcons, vultures
3.4.13	Heads of animals of Series IV, with horns	A 3.7.2	Heraldic eagles
A 3.4.14	Heads of stags	3.7.3	Cocks, hens, chickens
A 3.4.15	Heads of stags with cross between antlers	3.7.4	Turkeys, pheasants, peacocks, hoopoes
A 3.4.16	Heads of elk	3.7.5	Owls
3.4.18	Pigs and boars	3.7.6	Ducks, geese, swans
3.4.20	Heads of pigs or of boars	3.7.7	Storks, herons, cranes or other waders
A 3.4.22	Animals of Series IV bounding, galloping	3.7.8	Penguins
A 3.4.23	Animals of Series IV charging (attacking)	3.7.9	Albatross, cormorants, gulls
A 3.4.24	Animals of Series IV stylized	3.7.10	Swallows
A 3.4.25	Animals of Series IV in costume	3.7.11	Doves, pigeons, turtle-doves
		3.7.12	Jackdaws, crows, rooks, magpies
		3.7.13	Sparrows or other passerine birds
		3.7.14	Ostriches
		3.7.15	Parrots, budgerigars
		3.7.16	Birds in flight or with outspread wings
		3.7.17	Wings, stylized or not
			<u>Note:</u> (a) Including wings constituting a symbol or an emblem.
			(b) Not including wheels or wheel segments with wings (15.7.17), staves with wings (24.11.3) and Mercury's helmet (with wings) (24.11.14).
3.5	QUADRUPEDS (SERIES V), QUADRUMANA	3.7.19	Parts of birds, feathers, footprints, skeletons of birds
3.5.1	Rabbits, hares	3.7.20	Nests, bird cages
3.5.3	Squirrels		<u>Note:</u> Including nests with eggs. Eggs alone are classified in 8.7.11.
3.5.5	Beavers, marmots, badgers, martens, mink	3.7.21	Other birds
3.5.7	Rats, mice, moles	3.7.23	Bats
3.5.9	Hedgehogs, porcupines	A 3.7.24	Birds stylized
3.5.11	Pangolins	A 3.7.25	Birds in costume
3.5.15	Kangaroos		
3.5.17	Other quadrupeds belonging to Series I to V	3.9	AQUATIC ANIMALS, SCORPIONS
3.5.19	Quadrumana		<u>Note:</u> Not including aquatic animals of divisions 3.7, 3.11 or 3.13.
3.5.20	Heads of animals of Series V	3.9.1	Fish, animals of fish-like form
A 3.5.24	Animals of Series V stylized	A 3.9.2	Squali (sharks)
A 3.5.25	Animals of series V in costume	A 3.9.3	Cetaceans (sperm whales, whales, orcs, grampus, killer whales)
		A 3.9.4	Dolphins
3.6	PARTS OF THE BODIES, SKELETONS, SKULLS OF QUADRUPEDS OR OF QUADRUMANA	A 3.9.5	Swordfish, narwhal, sawfish
3.6.1	Parts of the bodies of quadrupeds or of quadrumana, skeletons, skulls	A 3.9.6	Ornamental fish
			<u>Note:</u> Including goldfish.
		A 3.9.7	Flat fish (sunfish, rays, dabs)
A 3.6.3	Paws, feet, pawprints, footprints	A 3.9.8	Snake-like (eels or others)
A 3.6.5	Skeletons, skulls of quadrupeds or of quadrumana	A 3.9.10	Other fish
		A 3.9.11	Fish in their element or represented as such

LIST OF CATEGORIES, DIVISIONS AND SECTIONS, WITH EXPLANATORY NOTES

- A 3.9.12 Groups of fish, or of animals of fish-like form, of different kinds
- 3.9.13 Parts of fish, fishbones
- 3.9.14 Sea horses
- 3.9.15 Inkfish, octopuses
- 3.9.16 Crustaceans (crabs, shrimps, crayfish, lobsters), scorpions
- 3.9.17 Starfish
- 3.9.18 Shellfish (oysters, mussels, conches, other shellfish)  
Note: Not including snails (3.11.7).
- 3.9.19 Coral, coral reef
- 3.9.21 Groups of aquatic animals of division 3.9, of different kinds (except A 3.9.12)
- 3.9.22 Aquariums, terrariums or vivariums containing animals of division 3.9
- 3.9.23 Other aquatic animals
- A 3.9.24 Animals of division 3.9 stylized
- A 3.9.25 Animals of division 3.9 in costume
- 3.11 REPTILES, AMPHIBIA, SNAILS, SEALS, SEA LIONS
- 3.11.1 Serpents
- A 3.11.2 Serpent and cup (symbol of medicine)
- A 3.11.3 Serpent(s) and staff
- 3.11.6 Worms
- 3.11.7 Snails, slugs
- 3.11.9 Alligators, caymans, crocodiles
- 3.11.10 Chameleons, lizards, salamanders
- 3.11.11 Tortoises
- 3.11.12 Toads, frogs, tadpoles
- 3.11.17 Seals, sea lions
- 3.11.21 Groups of animals of division 3.11, of different kinds
- 3.11.22 Terrariums or vivariums containing animals of division 3.11
- 3.11.23 Other animals belonging to division 3.11
- A 3.11.24 Animals of division 3.11 stylized
- A 3.11.25 Animals of division 3.11 in costume
- 3.13 INSECTS, SPIDERS, MICRO-ORGANISMS
- 3.13.1 Butterflies
- 3.13.2 Insects (except 3.13.1), spiders
- A 3.13.4 Bees, wasps
- 3.13.5 Beehives, cells of honeycombs
- A 3.13.6 Dragonflies
- A 3.13.7 Flies, mosquitoes
- A 3.13.8 Spiders, spider webs
- A 3.13.9 Ladybirds
- A 3.13.10 Beetles
- A 3.13.12 Cicadas, crickets, locusts, grasshoppers
- A 3.13.16 Ants
- A 3.13.17 Lice and aphides
- A 3.13.18 Caterpillars, silkworms
- A 3.13.19 Cocoons of silkworms, chrysalises
- 3.13.20 Micro-organisms
- 3.13.21 Groups of insects, spiders or micro-organisms, of different kinds
- A 3.13.23 Other insects
- A 3.13.24 Insects or spiders stylized
- A 3.13.25 Insects or spiders in costume
- 3.15 OTHER ANIMALS; LARGE PRE-HISTORIC ANIMALS
- Note: Not including fabulous animals of divisions 4.3 and 4.7.
- 3.17 GROUPS OF ANIMALS CLASSIFIED IN DIFFERENT DIVISIONS OF CATEGORY 3

4. SUPERNATURAL, FABULOUS, FANTASTIC OR UNIDENTIFIABLE BEINGS

Note: Not including human beings and fantastic animals composed of letters or figures and classified in the appropriate sections of division 27.3.

- 4.1 WINGED OR HORNED PERSONAGES
- 4.2 BEINGS PARTLY HUMAN AND PARTLY ANIMAL
- 4.3 FABULOUS ANIMALS
- 4.5 PLANTS, OBJECTS OR GEOMETRICAL FIGURES REPRESENTING A PERSONAGE OR AN ANIMAL; MASKS OR FANTASTIC OR UNIDENTIFIABLE HEADS
- 4.7 GROUPS OF FIGURATIVE ELEMENTS CLASSIFIED IN DIFFERENT DIVISIONS OF CATEGORY 4

- |   |  |
|---|--|
| <ul style="list-style-type: none"> <li>4.1 WINGED OR HORNED PERSONAGES                     <ul style="list-style-type: none"> <li>4.1.1 Winged human heads</li> <li>4.1.2 Winged children (cherubs, cupids)</li> <li>4.1.3 Other winged personages (except 4.1.4)</li> <li>4.1.4 Devils or other horned personages, with or without wings</li> <li>4.1.5 Heads of devils or horned personages</li> <li>4.1.25 Groups of winged or horned personages classified in different sections of division 4.1</li> </ul> </li> <li>4.2 BEINGS PARTLY HUMAN AND PARTLY ANIMAL                     <ul style="list-style-type: none"> <li>4.2.1 Centaurs</li> <li>A 4.2.2 Centaurs with bow, arrow(s) or lance</li> <li>4.2.5 Sphinx</li> <li>4.2.8 Tritons</li> <li>4.2.11 Sirens, naiads</li> <li>4.2.20 Other beings partly human and partly animal</li> <li>4.2.25 Groups of beings classified in different sections of division 4.2</li> </ul> </li> <li>4.3 FABULOUS ANIMALS                     <ul style="list-style-type: none"> <li>4.3.1 Winged lions, griffons</li> <li>4.3.3 Dragons</li> <li>4.3.5 Winged horses (Pegasus)</li> <li>4.3.7 Other winged quadrupeds</li> <li>4.3.9 Unicorns</li> <li>4.3.10 Monsters with several heads</li> <li>4.3.19 Heads of fabulous animals</li> <li>4.3.20 Phoenixes, other fabulous animals</li> <li>4.3.25 Groups of fabulous animals classified in different sections of division 4.3</li> </ul> </li> </ul> | <ul style="list-style-type: none"> <li>4.5 PLANTS, OBJECTS OR GEOMETRICAL FIGURES REPRESENTING A PERSONAGE OR AN ANIMAL; MASKS OR FANTASTIC OR UNIDENTIFIABLE HEADS                     <ul style="list-style-type: none"> <li>4.5.1 Personified plants, combinations of plants representing a personage</li> <li>4.5.2 Personified objects, combinations of objects representing a personage</li> <li>4.5.3 Personified geometrical figures or solids, combinations of geometrical figures or solids representing a personage</li> <li>4.5.4 Robots of human appearance</li> <li>4.5.5 Other unidentifiable personifications, other fantastic beings of human appearance                             <ul style="list-style-type: none"> <li><u>Note:</u> (a) Including snowmen, scarecrows and ghosts.</li> <li>(b) Not including dwarfs (2.1.7), allegorical or mythological personages (2.1.22 or 2.3.22), winged or horned creatures classified in division 4.1.</li> </ul> </li> </ul> </li> <li>4.5.11 Plants or combinations of plants representing an animal</li> <li>4.5.12 Objects or combinations of objects representing an animal</li> <li>4.5.13 Geometrical figures or solids or combinations of geometrical figures or solids representing an animal</li> <li>4.5.14 Robots having the appearance of animals</li> <li>4.5.15 Other forms representing an unidentifiable animal, other fantastic beings having the appearance of animals                             <ul style="list-style-type: none"> <li><u>Note:</u> Not including fabulous animals classified in division 4.3.</li> </ul> </li> <li>4.5.21 Masks or fantastic or unidentifiable heads</li> </ul> |
|---|--|



LIST OF CATEGORIES, DIVISIONS AND SECTIONS, WITH EXPLANATORY NOTES

5.	PLANTS		
5.1	TREES, BUSHES		
5.3	LEAVES, NEEDLES, BRANCHES WITH LEAVES OR NEEDLES		
5.5	FLOWERS, BLOSSOMS		
5.7	GRAIN, SEEDS, FRUITS		
5.9	VEGETABLES		
5.11	OTHER PLANTS		
5.13	DECORATIONS MADE OF PLANTS		
5.1	TREES, BUSHES	5.3.8	Wisteria leaves or acacia leaves
		5.3.9	Ginkgo leaves
5.1.1	Trees or bushes of triangular shape, conical shape (pointed at top), or "candle-flame" shape (firs, cypresses, etc.)	5.3.11	Other leaves
		. . .	
		A 5.3.13	Stylized leaves
5.1.2	Trees or bushes of oblong shape (poplars)	A 5.3.14	One leaf
		A 5.3.15	Two to four leaves
5.1.3	Trees or bushes of some other shape	5.3.16	More than four leaves, scattered leaves, bunches of leaves
5.1.4	Trees or bushes without leaves		<u>Note:</u> Not including surfaces or backgrounds covered with a repeated figurative element composed of leaves (25.7.25).
A 5.1.5	One tree or one bush		
A 5.1.6	Two trees or two bushes		
A 5.1.7	Three trees or three bushes		
A 5.1.8	More than three trees or three bushes, thickets, copses	5.3.17	Olive branches, with or without fruit
	<u>Note:</u> When the group of trees represented becomes a forest, it will be placed in 6.19.1 and A 6.19.5.	5.3.18	Mistletoe sprigs
		5.3.19	Vine shoots
			<u>Note:</u> Not including decorations of vine branches (5.13.6).
5.1.9	Groups of trees or of bushes of different shapes	5.3.20	Other branches with leaves, with or without fruit
A 5.1.10	Conifers	. . .	
A 5.1.11	Deciduous trees	5.3.22	Needles, branches with needles
A 5.1.12	Palm trees, banana trees	. . .	
A 5.1.14	Climbing bushes		
A 5.1.15	Trees and bushes in blossom	5.5	FLOWERS, BLOSSOMS
A 5.1.16	Trees or bushes in stylized form		<u>Note:</u> Including heraldic flowers.
5.1.19	Vine stocks, stumps	5.5.1	Roses
5.1.20	Trunks of trees without branches	5.5.2	Lilies
5.1.21	Large branches, branches without leaves or without needles	5.5.3	Tulips, magnolias
. . .		5.5.4	Marguerites
		5.5.5	Carnations
		5.5.6	Pansies
		5.5.7	Lilac or other flowers growing in vertical clusters
5.3	LEAVES, NEEDLES, BRANCHES WITH LEAVES OR NEEDLES	5.5.8	Wisteria or other flowers growing in drooping clusters
5.3.1	Tobacco leaves	. . .	
5.3.2	Oak leaves	5.5.10	Edelweiss
5.3.3	Holly leaves	5.5.11	Gentians
5.3.4	Vine leaves (except 5.3.19), plane leaves, maple leaves	5.5.12	Thistles
		5.5.13	Poppies
5.3.5	Leaves of chestnut trees	5.5.14	Chrysanthemums
5.3.6	Trefoils	5.5.15	Orchids
	<u>Note:</u> Including trefoils represented as symbols or appearing on playing cards.	5.5.16	Lotus flowers
		. . .	
5.3.7	Ferns, palms	5.5.18	Umbellate flowers
		5.5.19	Other flowers, blossoms
			<u>Note:</u> Including flowers or blossoms of trees (cherry trees, peach trees, apple trees) and of bushes.

LIST OF CATEGORIES, DIVISIONS AND SECTIONS, WITH EXPLANATORY NOTES

A 5.5.20	Stylized flowers	A 5.9.15	Aubergines, cucumbers, gherkins
A 5.5.21	One flower	A 5.9.17	Tomatoes
A 5.5.22	Several flowers (except 5.5.7, 5.5.8, 5.5.18 and 5.5.23) <u>Note:</u> Not including surfaces or backgrounds covered with a repeated figurative element composed of flowers (25.7.25).	A 5.9.19	Beans, peas
5.5.23	Groups of flowers of different kinds, bunches, sheaves or baskets of flowers, flower beds, scattered flowers	A 5.9.21	Other vegetables
...		A 5.9.23	One vegetable
		5.9.24	Groups of vegetables of different kinds
		...	
5.7	GRAIN, SEEDS, FRUITS	5.11	OTHER PLANTS
5.7.1	Grain, seeds <u>Note:</u> Including coffee beans.	5.11.1	Other plants
5.7.2	Ears of cereals (wheat, rye, barley, etc.) (except 5.7.4)	A 5.11.2	Roots, radicles, ginsengs
5.7.3	Panicles of cereals (oats, rice, etc.)	A 5.11.3	Mosses, lichens
5.7.4	Ears of maize, ears of sorghum	A 5.11.5	Mushrooms
5.7.5	Sheaves of cereals	A 5.11.9	Potato seedlings
5.7.6	Shell or husk fruits (almonds, peanuts, cocoa beans, walnuts, hazelnuts, etc.)	A 5.11.11	Grasses
5.7.7	Cupulate fruits (sweet chestnuts, edible chestnuts, acorns, etc.)	A 5.11.12	Wheat, rice
5.7.8	Strawberries, raspberries, blackberries	A 5.11.13	Bamboo, reeds, sugar canes, maize canes <u>Note:</u> Including bamboo shoots.
5.7.9	Other berries	A 5.11.14	Cotton plants
5.7.10	Grapes (single specimens or bunches)	A 5.11.15	Cones, fir cones
5.7.11	Oranges, mandarines or tangerines, grapefruit	A 5.11.17	Agaves, aloes
5.7.12	Lemons	A 5.11.18	Prickly pears
5.7.13	Apples	A 5.11.19	Cactus
5.7.14	Stone fruits (apricots, peaches, prunes, plums, dates, mangos, litchis, loquats, etc.) (except 5.7.16 and 5.7.19)	A 5.11.23	Plants in pots, in ornamental stands, in window-boxes or in tubs
5.7.15	Pears	...	
5.7.16	Cherries	5.13	DECORATIONS MADE OF PLANTS
5.7.17	Pineapples	5.13.1	Crowns of leaves, of flowers or of fruits
5.7.18	Bananas	5.13.3	Crossed palms
5.7.19	Olives	5.13.4	Crossed branches
5.7.21	Other fruits (except 5.7.9) <u>Note:</u> Including cotton bolls.	5.13.6	Decorations of vine branches <u>Note:</u> Not including vine shoots (5.3.19).
A 5.7.22	Open fruits, slices or quarters of fruit	5.13.7	Garlands, bands, borders or frames made of plants (except 5.13.6)
A 5.7.23	One fruit	A 5.13.8	Garlands, bands, borders or frames made of leaves
5.7.24	Groups of fruits of different kinds	A 5.13.9	Garlands, bands, borders or frames made of flowers
5.7.25	Bowls or baskets of fruit	A 5.13.10	Garlands, bands, borders or frames made of fruits
5.9	VEGETABLES	A 5.13.11	Garlands, bands, borders or frames made of other plants
5.9.1	Vegetables (except 5.9.24)	5.13.15	Christmas trees, branches of Christmas trees
A 5.9.3	Potatoes, other tubers	5.13.25	Other decorations made of plants <u>Note:</u> Not including bunches of leaves (5.3.16), bunches, sheaves or baskets of flowers (5.5.23), bowls or baskets of fruits (5.7.25) and surfaces or backgrounds covered with repeated figurative elements composed of plants (25.7.25).
A 5.9.6	Onions		
A 5.9.8	Leeks		
A 5.9.10	Asparagus		
A 5.9.12	Cabbages, lettuce <u>Note:</u> Not including lettuce prepared for immediate consumption (8.7.7).		
A 5.9.14	Gourds, melons, water melons		

LIST OF CATEGORIES, DIVISIONS AND SECTIONS, WITH EXPLANATORY NOTES

6.	<b>LANDSCAPES</b>		
6.1	<b>MOUNTAINS, ROCKS, GROTTOES</b>		
6.3	<b>LANDSCAPES WITH WATER, RIVER OR STREAM</b>		
6.6	<b>DESERT OR TROPICAL-TYPE LANDSCAPES</b>		
6.7	<b>URBAN LANDSCAPES OR VILLAGE SCENES</b>		
6.19	<b>OTHER LANDSCAPES</b>		
6.1	<b>MOUNTAINS, ROCKS, GROTTOES</b>	6.7	<b>URBAN LANDSCAPES OR VILLAGE SCENES</b>
6.1.1	Crags, rocks, walls of rocks <u>Note:</u> Not including reefs (6.3.1 and A 6.3.3).	6.7.1	Streets
6.1.2	Mountains, mountain landscapes	6.7.2	Squares
6.1.3	Volcanoes	6.7.4	Built-up areas
A 6.1.4	Mountains or volcanoes stylized	A 6.7.5	Built-up areas composed of skyscrapers
6.1.7	Grottoes	A 6.7.6	Built-up areas composed of flat-roofed houses
...		A 6.7.7	Built-up areas composed of huts
		A 6.7.8	Built-up areas composed of rural constructions
6.3	<b>LANDSCAPES WITH WATER, RIVER OR STREAM</b>	6.7.11	Urban landscapes or village scenes with water, river or stream
	<u>Note:</u> Not including urban landscapes or village scenes with water, river or stream (6.7.11).	6.7.25	Other urban landscapes or village scenes
6.3.1	Lacustrine or maritime scenes	6.19	<b>OTHER LANDSCAPES</b>
A 6.3.2	Beaches, coasts, bays	6.19.1	Other landscapes
A 6.3.3	Islands, reefs	A 6.19.5	Forest, undergrowth <u>Note:</u> A group of three or more trees will be placed in one of the sections 5.1.1 to 5.1.4 and in A 5.1.7 or A 5.1.8, if it does not represent a forest in the proper sense.
A 6.3.4	Open sea, stretches of water without shores	A 6.19.7	Vineyards
A 6.3.5	Lakes or seas with mountains around or in the background	A 6.19.9	Other cultivated areas
A 6.3.6	Harbors	A 6.19.11	Grasslands, pastures
A 6.3.10	Other lacustrine or maritime scenes	A 6.19.13	Pasturelands with mountains around or in the background
6.3.11	Landscapes with running water	A 6.19.15	Landscapes with windmills
A 6.3.12	Springs, landscapes with spring(s)	A 6.19.17	Landscapes with factory(ies) or other industrial construction(s)
A 6.3.13	Waterfalls, landscapes with waterfall(s)	A 6.19.19	Polar landscapes
A 6.3.14	Rivers, streams, rapids, torrents, with or without landscape	...	
A 6.3.20	Other landscapes with running water		
...			
6.6	<b>DESERT OR TROPICAL-TYPE LANDSCAPES</b>		
6.6.1	Desert landscapes or landscapes with very sparse vegetation		
6.6.2	Oases		
A 6.6.3	Other landscapes with palm trees		
6.6.25	Other tropical-type landscapes		

<b>7.</b>	<b>CONSTRUCTIONS, STRUCTURES FOR ADVERTISEMENTS, GATES OR BARRIERS</b>		
7.1	DWELLINGS, BUILDINGS, ADVERTISEMENT HOARDINGS OR PILLARS, CAGES OR KENNELS FOR ANIMALS		
7.3	PARTS OF DWELLINGS OR OF BUILDINGS, INTERIORS		
7.5	MONUMENTS, STADIUMS, FOUNTAINS		
7.11	STRUCTURAL WORKS		
7.15	BUILDING MATERIALS, WALLS, GATES OR BARRIERS, SCAFFOLDING		
7.1	DWELLINGS, BUILDINGS, ADVERTISEMENT HOARDINGS OR PILLARS, CAGES OR KENNELS FOR ANIMALS	7.3.12	Chimneys, chimney pots <u>Note:</u> Not including factory chimneys (7.1.14) and hearths (13.3.1 and A 13.3.2).
7.1.1	Castles, fortresses, crenellated walls, palaces	7.3.13	Shop window displays
7.1.3	Churches, cathedrals	7.3.15	Staircases
7.1.4	Mosques, minarets	7.3.20	Blinds, shutters, awnings
7.1.5	Pagodas	7.3.25	Other parts of dwellings or of buildings
7.1.6	Towers or masts, derricks (except 7.1.16) <u>Note:</u> Including transmitting masts.		
7.1.8	Houses, skyscrapers		
A 7.1.9	Rural houses, farms, barns	7.5	MONUMENTS, STADIUMS, FOUNTAINS
A 7.1.10	Flat-roofed houses	7.5.1	Pyramids
A 7.1.11	Chalets	7.5.2	Constructions recognized as monuments (Great Wall of China, etc.)
A 7.1.12	Urban houses, skyscrapers	7.5.5	Other ancient monuments
7.1.13	Windmills or water mills	A 7.5.6	Ancient temples or parts thereof
7.1.14	Industrial establishments, factory chimneys	A 7.5.8	Columns, obelisks
7.1.16	Lighthouses	7.5.9	Stadiums, amphitheatres, playgrounds, playing fields
7.1.17	Kiosks, shelters, fair booths, market stalls	7.5.10	Triumphal arches, porticos, town gates
7.1.18	Advertisement hoardings or pillars, other structures for advertisements	7.5.11	Labyrinths
7.1.19	Huts, cabins	7.5.15	Fountains, basins, swimming pools, sprays or jets of water, wells
7.1.20	Tents	7.5.25	Other monuments
7.1.21	Igloos		
7.1.22	Animals' cages or kennels <u>Note:</u> Not including bird cages (3.7.20) and beehives (3.13.5).		
A 7.1.23	Dwellings or buildings in ruins	7.11	STRUCTURAL WORKS
7.1.24	Dwellings or buildings stylized	7.11.1	Bridges
7.1.25	Other dwellings or buildings	7.11.5	Tunnels
7.3	PARTS OF DWELLINGS OR OF BUILDINGS, INTERIORS	7.11.10	Roads, intersections, road forks
7.3.1	Doors, entrances	7.11.15	Railway lines
7.3.2	Windows	7.11.20	Mooring posts, bollards
7.3.4	Interiors	7.11.23	Dams
A 7.3.5	Kitchens	7.11.25	Other structural works
A 7.3.6	Bathrooms and sauna-rooms		
A 7.3.7	Bedrooms		
A 7.3.8	Cellars		
A 7.3.9	Other interiors		
7.3.11	Roofs		

- 7.15 BUILDING MATERIALS, WALLS, GATES OR BARRIERS, SCAFFOLDING
- 7.15.1 Stones for building, bricks
- 7.15.5 Planks, plates, panels, flagstones
- 7.15.6 Corrugated iron or other corrugated materials
- 7.15.8 Representations of wood  
Note: Includes both the representation of natural wood surfaces, bark for instance, and that of wood cut with or against the grain. The representation of wood as an ornamental background will be placed in the appropriate sections of category 25.
- 7.15.20 Other building materials
- 7.15.22 Walls, gates or barriers
- 7.15.25 Scaffolding

LIST OF CATEGORIES, DIVISIONS AND SECTIONS, WITH EXPLANATORY NOTES

<b>8.</b>	<b>FOODSTUFFS</b>		
<b>8.1</b>	<b>BAKERS' PRODUCTS, PASTRY, CONFECTIONERY, CHOCOLATE</b>		
<b>8.3</b>	<b>MILK, DAIRY PRODUCTS, CHEESES</b>		
<b>8.5</b>	<b>BUTCHERS' MEAT, PORK PRODUCTS, FISHMONGERS' PRODUCTS</b>		
<b>8.7</b>	<b>OTHER FOODSTUFFS</b>		
<b>8.1</b>	<b>BAKERS' PRODUCTS, PASTRY, CONFECTIONERY, CHOCOLATE</b>	<b>8.5</b>	<b>BUTCHERS' MEAT, PORK PRODUCTS, FISHMONGERS' PRODUCTS</b>
8.1.1	Bread	8.5.1	Butchers' meat, pork products, fishmongers' products
A 8.1.2	Pan loaves of square or rectangular shape	A 8.5.2	Ham, legs of mutton, joints of meat
A 8.1.3	Long loaves, French bread (bread sticks)	A 8.5.3	Sausages ("fresh"), sausages ("dry"), salami
A 8.1.4	Loaves of round or cylindrical shape	A 8.5.4	Butchers' meat, pork products or fish in slices
8.1.6	Rusks, slices of bread, slices of bread spread with butter, jam or other edible substance of similar consistency	A 8.5.10	Poultry or game cooked or prepared for cooking
8.1.7	Bread rolls, brioches	A 8.5.15	Fish, fish fillets or other fishmongers' products cooked or prepared for cooking
8.1.8	Croissants	A 8.5.25	Other butchers' meat, other pork products
8.1.9	Small biscuits		
A 8.1.10	Small biscuits of round shape (except A 8.1.12)		
A 8.1.11	Small biscuits of square or rectangular shape (except A 8.1.12)		
A 8.1.12	Small biscuits with lobed edges		
A 8.1.13	Small biscuits of triangular shape (except A 8.1.12)		
A 8.1.14	Mixtures of small biscuits of different shapes	<b>8.7</b>	<b>OTHER FOODSTUFFS</b>
8.1.15	Pastries	8.7.1	Soups or beverages (in plates, in cups, in bowls, in soup tureens, in glasses, etc.)
A 8.1.16	Tarts, flans, pies		
A 8.1.17	Cakes	8.7.3	Macaroni, other pasta
8.1.18	Ices	8.7.5	Dishes or plates, filled
8.1.19	Chocolate, confectionery	8.7.7	Dishes of vegetables, vegetable salads
A 8.1.20	Slabs of chocolate	8.7.11	Eggs of all kinds, eggs cooked
A 8.1.21	Sticks of chocolate	8.7.14	Fruit salads, compotes of fruit
A 8.1.22	Squares of chocolate, pralines, fondants or other sweets (except A 8.1.23)	8.7.15	Baked custard, puddings, omelettes
A 8.1.23	Pralines, fondants or other wrapped sweets	8.7.17	Mixtures of foodstuffs classified in different divisions
A 8.1.24	Lollipops		
8.1.25	Other bakers' products	8.7.21	Sugar
		8.7.22	Foodstuffs for dogs and cats (nuggets)
<b>8.3</b>	<b>MILK, DAIRY PRODUCTS, CHEESES</b>	8.7.25	Other foodstuffs not classified in 8.7.1 to 8.7.22
8.3.1	Milk, cream (except 8.3.2)		
8.3.2	Whipped cream		
8.3.3	Butter, margarine		
A 8.3.4	Butter or margarine in pats		
A 8.3.5	Butter or margarine in slabs		
A 8.3.6	Butter or margarine in shell shape		
A 8.3.7	Butter or margarine in some other shape		
8.3.8	Cheeses		
A 8.3.9	Cheeses of round shape		
A 8.3.10	Cheeses of square or rectangular shape		
A 8.3.11	Cheeses of some other shape (uncut)		
A 8.3.12	Cheese cut up		
8.3.25	Other dairy products (except 8.7.15)		

9.	TEXTILES, CLOTHING, SEWING ACCESSORIES, HEADWEAR, FOOTWEAR		
9.1	TEXTILES OTHER THAN CLOTHING, SHUTTLES		
9.3	CLOTHING		
9.5	SEWING ACCESSORIES, PATTERNS FOR DRESSMAKING		
9.7	HEADWEAR		
9.9	FOOTWEAR		
9.1	TEXTILES OTHER THAN CLOTHING, SHUTTLES		
9.1.1	Thread	A 9.3.8	Pullovers, sweaters
A 9.1.2	Thread wound into a skein	A 9.3.9	Shirts, T-shirts, bodices, shirt-blouses
A 9.1.3	Thread wound on a bobbin or on some other support (except A 9.1.4)	A 9.3.10	Collars of clothing
A 9.1.4	Thread wound on a shuttle, shuttles with or without thread	A 9.3.13	Ties, bow ties, silk scarves
A 9.1.5	Thread wound into a ball	A 9.3.14	Underwear, underpants, diapers, bathing costumes
A 9.1.6	Other presentations of thread	A 9.3.15	Stockings, socks, bootees
9.1.7	Laces, braids, tapes, cords	A 9.3.16	Gloves
9.1.8	Stitches	A 9.3.17	Belts, buckles for belts
9.1.9	Embroidery, tea cloths, tray cloths, trimmings	A 9.3.18	Bibs
9.1.10	Ribbons, bows	A 9.3.19	Clothing pockets
9.1.11	Cloth, network, flat linen, curtains, carpets	A 9.3.20	Parts of clothing of division 9.3 (except A 9.3.10 and A 9.3.19)
	<u>Note:</u> Not including nets for fishing, hunting or games (21.3.16).	A 9.3.25	Other clothing not classified in divisions 9.7 and 9.9
A 9.1.15	Network, loose weaving, chain stitches		
A 9.1.16	Cloth edged with a thread or one or more distinctive bands	9.5	SEWING ACCESSORIES, PATTERNS FOR DRESSMAKING
A 9.1.17	Flat linen		
	<u>Note:</u> Including handkerchiefs and babies' napkins.	9.5.1	Needles, thimbles, hooks, pins
A 9.1.18	Cloth in pieces or in rolls	A 9.5.2	<u>Note:</u> See also 14.3.1 to A 14.3.7.
A 9.1.19	Cloth in piles	A 9.5.3	Sewing needles, straight or curved
A 9.1.20	Draped cloth, curtains		Knitting needles
A 9.1.21	Carpets, cloth with fringes	A 9.5.5	Thimbles
A 9.1.22	Cloth labels, with scalloped edges or not, samples of cloth	A 9.5.6	Crochet hooks
9.1.23	Bed coverings, cushions, eiderdowns	A 9.5.7	Fastening hooks
	<u>Note:</u> Bolsters are classified in 12.1.1 and A 12.1.4.	A 9.5.8	Pins (except A 9.5.9)
		A 9.5.9	Safety pins
9.1.25	Other textile articles not classified in divisions 9.3, 9.7 and 9.9	9.5.10	Other sewing accessories
			<u>Note:</u> Not including scissors (14.7.18 and A 14.7.20) and tape measures (17.5.1 and A 17.5.2).
		A 9.5.12	Buttons (except A 9.5.13)
		A 9.5.13	Press studs
9.3	CLOTHING		
	<u>Note:</u> Not including headwear (9.7) and footwear (9.9).	A 9.5.15	Slide fasteners
9.3.1	Clothing	A 9.5.16	Patterns for clothing
A 9.3.2	Jackets, waistcoats, coats, cloaks		<u>Note:</u> Patterns resembling clothing will be placed in 9.3.
A 9.3.3	Trousers, breeches	A 9.5.17	Corset whalebones
A 9.3.4	Suits or costumes (except A 9.3.5 and A 9.3.14)	A 9.5.25	Other sewing accessories not classified in 9.5.1 to A 9.5.9
A 9.3.5	Dresses, aprons, ladies' suits or costumes		

- 9.7 HEADWEAR
- 9.7.1 Headwear
- A 9.7.5 Caps and berets
- A 9.7.9 Cocked hats
- A 9.7.11 Kepis
- A 9.7.13 Phrygian caps
- A 9.7.15 Fez
- A 9.7.17 Broad-brimmed hats (Mexican hats or cowboys' hats)
- A 9.7.19 Cooks' caps
- A 9.7.21 Protective helmets  
Note: Not including helmets as parts of armour (23.5.5) and Mercury's helmet (with wings) (24.11.14).
- A 9.7.25 Other headwear
- 9.9 FOOTWEAR
- 9.9.1 Footwear
- A 9.9.2 Clogs
- A 9.9.3 Low-heeled shoes
- A 9.9.5 High-heeled shoes
- A 9.9.7 Boots, top boots
- A 9.9.11 Sports footwear
- A 9.9.13 Babies' footwear
- A 9.9.15 Soles of boots and shoes, footprints left by boots and shoes
- A 9.9.17 Other parts of footwear  
Note: Not including fastening hooks (9.5.1 and A 9.5.7), buttons (9.5.10 and A 9.5.12), press studs (9.5.10 and A 9.5.13), slide fasteners (9.5.10 and A 9.5.15), nails (14.3.1 and A 14.3.2) and eyelets (14.3.10 and A 14.3.13).
- A 9.9.25 Other footwear



LIST OF CATEGORIES, DIVISIONS AND SECTIONS, WITH EXPLANATORY NOTES

10.	TOBACCO, SMOKERS' REQUISITES, MATCHES, TRAVEL GOODS, FANS, TOILET ARTICLES		
10.1	TOBACCO, SMOKERS' REQUISITES, MATCHES		
10.3	TRAVEL GOODS, FANS, BAGS		
10.5	TOILET ARTICLES, MIRRORS		
10.1	TOBACCO, SMOKERS' REQUISITES, MATCHES	10.5	TOILET ARTICLES, MIRRORS
10.1.1	Tobacco	10.5.1	Toothbrushes, dose of toothpaste
A 10.1.2	Cut tobacco	10.5.4	Shaving articles (except 10.5.21)
A 10.1.3	Cigars	A 10.5.5	Open razors
A 10.1.5	Cigarettes	A 10.5.6	Safety razors
A 10.1.7	Tobacco in any other form <u>Note:</u> Not including tobacco leaves, dried or not (5.3.1).	A 10.5.7	Blades for safety razors
10.1.10	Smokers' requisites, matches	A 10.5.8	Electric razors
A 10.1.11	Pipes	A 10.5.9	Shaving brushes
A 10.1.12	Hookahs	10.5.11	Hair clippers
A 10.1.13	Cigarette holders and cigar holders	10.5.13	Combs
A 10.1.14	Pipe cleaners	10.5.15	Lipsticks
A 10.1.15	Cigar cutters	10.5.17	Mirrors <u>Note:</u> Not including mirrors used in medicine (19.13.1 and A 19.13.25).
A 10.1.16	Tobacco jars	10.5.19	Sprays for toilet purposes
A 10.1.17	Tobacco pouches	10.5.21	Soap
A 10.1.18	Lighters	10.5.25	Other toilet articles, other cosmetic or toilet products <u>Note:</u> Not including sponges (11.7.1 and A 11.7.5) and packaging (cases, tubes, bottles, etc.) containing cosmetic or toilet products classified in divisions 19.3 or 19.7.
A 10.1.19	Ash trays		
A 10.1.20	Matches		
A 10.1.25	Other smokers' requisites		
10.3	TRAVEL GOODS, FANS, BAGS		
10.3.1	Sticks, umbrellas, parasols		
A 10.3.4	Open umbrellas or parasols		
10.3.7	Fans		
10.3.10	Bags, suitcases, trunks		
A 10.3.11	Shopping bags		
A 10.3.13	Handbags		
A 10.3.14	Handbag, suitcase or trunk fasteners <u>Note:</u> Not including slide fasteners (9.5.10 and A 9.5.15).		
A 10.3.15	Rucksacks		
A 10.3.16	Suitcases, trunks		
10.3.25	Other travel goods		

11. HOUSEHOLD UTENSILS

Note: Not including household utensils classified in categories 12, 13 or 19.

11.1 KNIVES, FORKS AND SPOONS, KITCHEN UTENSILS AND MACHINES

11.3 CONTAINERS FOR BEVERAGES, PLATES AND DISHES, KITCHEN UTENSILS FOR SERVING, PREPARING OR COOKING FOOD OR DRINK

11.7 OTHER HOUSEHOLD UTENSILS

- |           |   |           |  |
|-----------|---|-----------|--|
| 11.1      | KNIVES, FORKS AND SPOONS, KITCHEN UTENSILS AND MACHINES   | 11.3.14   | Tea pots, coffee pots, kettles   |
| 11.1.1    | Knives, forks and spoons  | 11.3.18   | Saucepans, pots, stewpans, frying pans, cauldrons                            |
| A 11.1.2  | Spoons  | A 11.3.20 | Containers, plates or dishes containing food or drink                        |
| A 11.1.3  | Knives  | A 11.3.23 | Plates and dishes with knives, forks or spoons                               |
| A 11.1.4  | Forks   | A 11.3.25 | Other plates and dishes  |
| A 11.1.5  | Sets consisting of knife(ves), fork(s) and/or spoon(s)  | 11.7      | OTHER HOUSEHOLD UTENSILS   |
| A 11.1.6  | Chopsticks  | 11.7.1    | Household utensils not classified in divisions 11.1 or 11.3                  |
| A 11.1.9  | Spatulas, other table implements  | A 11.7.2  | Irons  |
| 11.1.10   | Kitchen utensils and machines   | A 11.7.3  | Coat hangers   |
|           | <u>Note:</u> Not including kitchen utensils and machines of divisions 11.3 and 13.3 and mortars (19.11.1).    | A 11.7.5  | Brushes, sponges, steel wool   |
| A 11.1.11 | Funnels   |           | <u>Note:</u> Not including brushes for toilet purposes (10.5.1 and 10.5.25). |
| A 11.1.13 | Strainers, colanders  | A 11.7.7  | Brooms, window cleaning instruments  |
| A 11.1.14 | Tin openers, bottle openers, corkscrews   |           |  |
| A 11.1.15 | Vegetable grinders, meat mincers  |           |  |
| A 11.1.17 | Chopping or carving boards  |           |  |
| A 11.1.18 | Coffee filters  |           |  |
| A 11.1.19 | Coffee mills  |           |  |
| A 11.1.20 | Pepper mills  |           |  |
| A 11.1.21 | Mixers  |           |  |
| A 11.1.25 | Other kitchen utensils or machines  |           |  |
| 11.3      | CONTAINERS FOR BEVERAGES, PLATES AND DISHES, KITCHEN UTENSILS FOR SERVING, PREPARING OR COOKING FOOD OR DRINK |           |  |
|           | <u>Note:</u> Not including kitchen utensils classified in 11.1.   |           |  |
| 11.3.1    | Drinking vessels, cups (trophies)   |           |  |
| A 11.3.2  | Glasses with or without stems, without handles  |           |  |
| A 11.3.3  | Tankards, glasses with handles  |           |  |
| A 11.3.4  | Cups, cups with saucers   |           |  |
| 11.3.5    | Eating or serving vessels   |           |  |
| A 11.3.7  | Bowls   |           |  |
| A 11.3.8  | Serving jugs  |           |  |
| A 11.3.9  | Plates, saucers   |           |  |
| A 11.3.10 | Dishes, fruit dishes, salad bowls, fruit bowls  |           |  |
| A 11.3.11 | Sauce boats, soup tureens   |           |  |
| A 11.3.13 | Cruets, salt cellars, pepper casters, mustard pots  |           |  |

- 12. FURNITURE, SANITARY INSTALLATIONS
  - 12.1 FURNITURE
    - 12.3 SANITARY INSTALLATIONS
      - 12.1 FURNITURE
        - Note: Including office furniture.
        - 12.1.1 Furniture
        - A 12.1.2 Cots
        - A 12.1.3 Beds
        - A 12.1.4 Mattresses, wedges, bolsters
          - Note: Cushions are classified in 9.1.23.
        - A 12.1.5 Cradles
        - A 12.1.9 Chairs, armchairs, stools
        - A 12.1.10 Benches, forms, seats, sofas
        - A 12.1.15 Tables, work benches, butchers' blocks, shop counters
        - A 12.1.17 Chests of drawers, trunks
        - A 12.1.19 Cupboards, sideboards
        - A 12.1.21 Sets of shelves, whatnots, dressers
        - A 12.1.25 Other pieces of furniture
          - Note: Not including mirrors (10.5.17).
- 12.3 SANITARY INSTALLATIONS
  - 12.3.1 Sanitary installations
  - A 12.3.2 Washbasins
  - A 12.3.3 Baths
  - A 12.3.7 Water closets and bidets, flushing cisterns
  - A 12.3.11 Taps
    - Note: Including taps which are not part of a sanitary installation.
  - A 12.3.25 Other sanitary installations

- 13. LIGHTING, WIRELESS VALVES, HEATING, COOKING OR REFRIGERATING EQUIPMENT, WASHING MACHINES, DRYING EQUIPMENT
  - 13.1 LIGHTING, WIRELESS VALVES
    - 13.1.1 Candles, candlesticks
    - A 13.1.2 Candlesticks (except A 13.1.3)
    - A 13.1.3 Candlesticks with several branches
    - 13.1.5 Flambeaux, torches (except 13.1.6 and A 13.1.14)
    - 13.1.6 Lamps, fairy lights, lanterns, wireless valves
    - A 13.1.7 Oil lamps, lamps emitting a faint light
    - A 13.1.8 Fairy lights, lanterns (except A 13.1.9)
    - A 13.1.9 Hurricane lamps
    - A 13.1.10 Street lamps, standard lamps
    - A 13.1.11 Table lamps, Argand lamps, lampshades
    - A 13.1.12 Hanging lamps
    - A 13.1.13 Bracket lamps
    - A 13.1.14 Electric torches, pocket lamps
    - A 13.1.15 Flashlights for signalling
    - A 13.1.16 Vehicle headlights
    - A 13.1.17 Electric light bulbs or tubes
    - A 13.1.18 Wireless valves
    - A 13.1.20 Parts of lamps (except A 13.1.11 and A 13.1.17)
    - A 13.1.25 Other lighting apparatus
  - 13.3 HEATING, COOKING OR REFRIGERATING EQUIPMENT, WASHING MACHINES, DRYING EQUIPMENT
    - 13.3.1 Heating, cooking or refrigerating equipment
    - A 13.3.2 Hearths, braziers, other heating apparatus with open fire
    - A 13.3.3 Boilers for heating, stoves for rooms
    - A 13.3.5 Radiators, sauna heating equipment, other heating apparatus
    - A 13.3.6 Parts of heating apparatus
    - A 13.3.7 Kitchen stoves, plate warmers and dish heaters, grills
    - A 13.3.9 Other cooking equipment
    - A 13.3.21 Refrigerating equipment
    - 13.3.23 Washing machines, dishwashers (machines)
    - 13.3.24 Household drying equipment

<b>14.</b>	<b>IRONMONGERY, TOOLS, LADDERS</b>		
14.1	TUBES, CABLES, HEAVY IRONMONGERY ARTICLES		
14.3	SMALL IRONMONGERY ARTICLES, SPRINGS		
14.5	KEYS FOR LOCKS, LOCKS, PADLOCKS		
14.7	TOOLS		
14.9	AGRICULTURAL OR HORTICULTURAL IMPLEMENTS, ICE AXES		
14.11	LADDERS		
14.1	TUBES, CABLES, HEAVY IRONMONGERY ARTICLES	A 14.3.9	Screw nuts
	<u>Note:</u> Including representations of non-metallic ironmongery articles.	A 14.3.11	Hooks <u>Note:</u> Not including fastening hooks for clothing (9.5.1 and A 9.5.7).
14.1.1	Tubes, pipes, sluices	A 14.3.13	Terminal connectors for cables, cable clamps, collars, junction sleeves, rings, washers, eyelets, segments, joints
A 14.1.2	Tubes or pipes, bent, coiled or twisted		
A 14.1.3	Joints of pipes or of tubes, sluices		
14.1.5	Bars, cables <u>Note:</u> (a) Including electric cables. (b) See also 9.1.7.	A 14.3.15	Door handles, window handles, hinges, butt-hinges
A 14.1.6	Bars or cables, braided or twisted	A 14.3.16	Door bolts, latches
A 14.1.7	Sections of cables	14.3.20	Other small ironmongery articles
A 14.1.8	Cables with distinctive wires or with sections of different colors	14.3.21	Springs <u>Note:</u> (a) Includes all springs, of whatever kind or for whatever purpose. (b) Does not include door closers (15.1.25).
A 14.1.10	Cables or cords with electric plugs		
14.1.13	Chains, links of chain		
A 14.1.14	Block chains (for bicycles, motorcycles, etc.)		
A 14.1.15	Links of chain		
A 14.1.16	Chains forming a ring		
14.1.18	Other heavy ironmongery articles	14.5	KEYS FOR LOCKS, LOCKS, PADLOCKS
A 14.1.19	Girders, spars, rods, rails	14.5.1	Keys, part of keys
A 14.1.20	Profiles of girders, of spars, of rods or of rails	A 14.5.2	One key
		A 14.5.3	Two keys
A 14.1.22	Iron rods for reinforcing concrete, structural frameworks of such iron	A 14.5.6	More than two keys
A 14.1.23	Barbed wire	A 14.5.9	Parts of keys
A 14.1.24	Wire netting		
A 14.1.25	Other heavy ironmongery articles	A 14.5.12	Keys with bows of circular, oval or constricted oval shape
		A 14.5.13	Keys with lobed bows
		A 14.5.14	Keys with diamond-shaped bows, figured or otherwise, with straight or concave edge
14.3	SMALL IRONMONGERY ARTICLES, SPRINGS	A 14.5.15	Keys of some other shape
14.3.1	Nails, screws, bolts, rivets, dowel pins, screw nuts, drawing pins <u>Note:</u> See also 9.5.1 to A 9.5.8.	A 14.5.18	Flat keys
A 14.3.2	Nails	A 14.5.19	Other keys
A 14.3.3	Screws, bolts, rivets, dowel pins, drawing pins	14.5.20	Keyrings, with or without keys
		14.5.21	Locks, escutcheons
A 14.3.7	Nails, screws, bolts, rivets and/or dowel pins, crossed <u>Note:</u> See also 9.5.1 to A 9.5.8.	14.5.23	Padlocks

- 14.7 TOOLS
- Note: Not including agricultural or horticultural implements classified in division 14.9.
- 14.7.1 Hammers, sledge-hammers  
14.7.2 Axes  
A 14.7.3 Two hammers, two sledge-hammers or two axes, crossed  
14.7.4 Anvils, shoemakers' lasts  
14.7.6 Other tools (except 14.7.18 to 14.7.23)  
A 14.7.7 Tongs, pincers  
A 14.7.8 Tweezers  
A 14.7.9 Wedge keys  
A 14.7.11 Braces, bow handles, hand drills  
A 14.7.12 Power drills, pneumatic hammers  
A 14.7.13 Bits (for drills), drills  
A 14.7.14 Sharpening stones  
A 14.7.15 Saws, saw benches  
A 14.7.16 Saw blades or belts of band saws  
Note: Not including sawtoothed wheels and disks of circular saws (15.7.1 and A 15.7.2).  
14.7.18 Cutlery  
Note: Not including open razors (10.5.4 and A 10.5.5), table knives (11.1.1 and A 11.1.3) and daggers (23.1.1).  
A 14.7.19 Knives  
A 14.7.20 Scissors (except A 14.7.21)  
A 14.7.21 Sheep shears  
14.7.23 Bricklayers' trowels and plasterers' hawks  
...
- 14.9 AGRICULTURAL OR HORTICULTURAL IMPLEMENTS, ICE AXES
- 14.9.1 Spades  
A 14.9.2 Spades, round or pointed  
A 14.9.3 Spades, rectangular or square  
14.9.5 Pickaxes, ice axes, hoes  
14.9.7 Scythes, sickles  
14.9.10 Other agricultural or horticultural implements  
A 14.9.11 Rakes  
A 14.9.13 Ploughs, ploughshares  
...
- 14.11 LADDERS
- 14.11.1 Ladders  
A 14.11.2 Single ladders  
A 14.11.3 Double ladders  
...

15. MACHINERY, MOTORS, ENGINES

- 15.1 MACHINES FOR INDUSTRY OR AGRICULTURE, INDUSTRIAL INSTALLATIONS, MOTORS, ENGINES, VARIOUS MECHANICAL APPLIANCES
- 15.3 MACHINES FOR HOUSEHOLD USE, SPINNING WHEELS
- 15.5 OFFICE MACHINES
- 15.7 WHEELS, BEARINGS
- 15.9 ELECTRICAL EQUIPMENT

- 15.1 MACHINES FOR INDUSTRY OR AGRICULTURE, INDUSTRIAL INSTALLATIONS, MOTORS, ENGINES, VARIOUS MECHANICAL APPLIANCES
  - A 15.3.3 Sewing machines
  - A 15.3.5 Vacuum cleaners, polishers
  - A 15.3.9 Other household machines
  - 15.3.11 Spinning wheels, distaffs

Note: Not including machines for household use and spinning wheels (15.3) or office machines (15.5).
- 15.1.1 Machines for industry and industrial installations (such as for pressing, grinding, mixing, distilling or excavating)
  - 15.5 OFFICE MACHINES
    - 15.5.1 Typewriters
 

Note: Not including word processors (16.1.4 and A 16.1.6).
    - 15.5.25 Other office machines
- 15.1.7 Conveyor belts
- 15.1.11 Motors, engines
- 15.1.13 Propellers, ventilators, blowers, turbines, burners
 

Note: Includes all kinds of propellers, including those for aircraft or ships.
- 15.1.17 Parts of machines for industry or agriculture, of industrial installations or of motors and engines (including robotic arms)
  - 15.7 WHEELS, BEARINGS
    - 15.7.1 Cog wheels, wheel cogs
    - A 15.7.2 Sawtoothed wheels, disks of circular saws
    - A 15.7.3 Segments of cog wheels, wheel cogs
    - A 15.7.4 Cog wheels or segments of cog wheels with spokes
    - 15.7.7 Ships' wheels, capstans, paddle wheels
    - 15.7.9 Other wheels, with or without spokes
 

Note: Not including tyred wheels and vehicle wheels mounted on axles (18.1.21).
    - 15.7.11 Ball bearings and other bearings
    - 15.7.15 Gearing, several wheels in juxtaposition, transmission wheels
    - 15.7.17 Wheels or wheel segments with wings
    - A 15.7.18 Wheels or bearings without any inscription or design
    - A 15.7.19 Wheels or bearings with inscription
    - A 15.7.20 Wheels or bearings with human beings, animals or plants
    - A 15.7.21 Wheels or bearings with other figurative elements
- 15.1.19 Cranes, blocks and tackle, pulleys
- 15.1.21 Sprayers, paint sprayguns, fire extinguishers
- 15.1.22 Machines for agriculture
 

Note: Tools for agriculture are classified in division 14.9.
- 15.1.23 Petrol pumps
- 15.1.24 Automatic distributors, coin-freed vending machines (except 15.1.23)
- 15.1.25 Various other mechanical appliances
 

Note: (a) Including door closers.  
(b) Not including power drills and pneumatic hammers (14.7.6 and A 14.7.12).
- 15.3 MACHINES FOR HOUSEHOLD USE, SPINNING WHEELS
  - 15.3.1 Machines for household use
 

Note: Not including kitchen machines (11.1.10), washing machines (13.3.23) and household drying equipment (13.3.24).

15.9 ELECTRICAL EQUIPMENT

Note: Not including electric lamps and wireless valves (13.1.6, A 13.1.17 and A 13.1.18) or electric cables (14.1.5).

- 15.9.1 Electrical equipment
- A 15.9.2 Batteries, piles
- A 15.9.3 Sparking plugs
- A 15.9.9 Electrical accessories for vehicles (except A 15.9.2 and A 15.9.3)
  - Note: Not including flashing signal lamps (13.1.6 and A 13.1.15) and vehicle headlamps (13.1.6 and A 13.1.16).
- A 15.9.10 Electric plugs
- A 15.9.11 Switches
- A 15.9.15 Insulators
- A 15.9.16 Transistors, diodes and resistors
- A 15.9.18 Integrated circuits
- A 15.9.25 Other electrical apparatus



- 16. TELECOMMUNICATIONS, SOUND RECORDING OR REPRODUCTION, COMPUTERS, PHOTOGRAPHY, CINEMATOGRAPHY, OPTICS
- 16.1 TELECOMMUNICATIONS, SOUND RECORDING OR REPRODUCTION, COMPUTERS
- 16.3 PHOTOGRAPHY, CINEMATOGRAPHY, OPTICS
  
- 16.1 TELECOMMUNICATIONS, SOUND RECORDING OR REPRODUCTION, COMPUTERS
- 16.1.1 Aerials; pylons, posts or lines for telephone or electricity
- 16.1.4 Telecommunication, television, sound recording or sound reproduction apparatus and equipment, computers
- A 16.1.5 Radio or television apparatus  
Note: (a) Including apparatus for reproduction of images (video).  
 (b) Not including wireless valves (13.1.6 and A 13.1.18).
- A 16.1.6 Computers, word processors
- A 16.1.11 Telephone receivers
- A 16.1.15 Record players
- A 16.1.16 Discs for sound, image and data recording and reproduction; sleeves and boxes for discs
- A 16.1.17 Recording tapes, cassettes for recording tapes
- A 16.1.25 Other apparatus for telecommunication or the recording or reproduction of sound
  
- 16.3 PHOTOGRAPHY, CINEMATOGRAPHY, OPTICS
- 16.3.1 Photographic or cinematographic apparatus, projection apparatus and lanterns  
Note: Including video cameras and photographic lenses.
- A 16.3.3 Iris diaphragms
- A 16.3.5 Films, containers for films
- 16.3.11 Other apparatus, instruments or equipment for photography or the cinema
- 16.3.13 Spectacles, spectacle frames
- 16.3.15 Binoculars, telescopes, field glasses, microscopes
- 16.3.17 Magnifying glasses with handle
- 16.3.19 Optical lenses, spectacle lenses
- 16.3.25 Other optical apparatus, instruments or equipment

17.	<b>HOROLOGICAL INSTRUMENTS, JEWELRY, WEIGHTS AND MEASURES</b>		
17.1	HOROLOGICAL AND OTHER TIME-MEASURING INSTRUMENTS		
17.2	JEWELRY		
17.3	BALANCES, WEIGHTS		
17.5	MEASURES		
17.1	HOROLOGICAL AND OTHER TIME-MEASURING INSTRUMENTS	17.3	BALANCES, WEIGHTS
17.1.1	Horological instruments	17.3.1	Balances, weights
A 17.1.2	Circular dials with or without hands <u>Note:</u> Not including dials of measuring instruments other than horological (17.5.1 and A 17.5.17).	A 17.3.2	Balances with two trays
		A 17.3.3	Other balances
		A 17.3.5	Parts of balances
A 17.1.3	Dials not being circular, with or without hands <u>Note:</u> Not including dials of measuring instruments other than horological (17.5.1 and A 17.5.17).	A 17.3.11	Weights
A 17.1.5	Hands of horological instruments	17.5	MEASURES
A 17.1.6	Other parts of horological instruments <u>Note:</u> Not including spiral springs (14.3.21).		<u>Note:</u> Including calculating instruments.
A 17.1.7	Watches	17.5.1	Measures <u>Note:</u> Not including time-measuring instruments, classified in 17.1, or balances and weights, classified in 17.3.
A 17.1.9	Clocks, alarm clocks	A 17.5.2	Instruments for linear measurement (yardsticks, graduated rulers, tape measures, surveyors' tapes and chains)
A 17.1.13	Watch bracelets	A 17.5.3	Slide rules, calculating disks and cylinders
17.1.17	Sundials	A 17.5.4	Abacuses
17.1.19	Sandglasses	A 17.5.5	Gauges, calipers
17.1.25	Other time-measuring instruments	A 17.5.7	Compasses for draftsmen and masons
		A 17.5.9	Squares, French curves, T-squares
17.2	JEWELRY	A 17.5.13	Plumb lines, lead weights for plumb lines
17.2.1	Precious stones	A 17.5.15	Levels
A 17.2.2	Precious stones cut in facets	A 17.5.17	Dials of measuring instruments <u>Note:</u> Not including dials of horological instruments (17.1.1 and A 17.1.2 or A 17.1.3).
A 17.2.4	Other representations of precious stones		
17.2.5	Pearls	A 17.5.19	Thermometers
A 17.2.6	Pearls or precious stones in an oyster	A 17.5.21	Compasses, mariners' compasses <u>Note:</u> Not including compass cards (1.1.17).
17.2.13	Necklaces, bracelets, jewelry chains		
17.2.17	Rings and wedding rings	A 17.5.25	Other measuring instruments, markers
17.2.25	Other jewels <u>Note:</u> Including cuff links, tie pins and hat pins.		

<b>18.</b>	<b>TRANSPORT, EQUIPMENT FOR ANIMALS</b>		
18.1	LAND VEHICLES		
18.2	EQUIPMENT FOR ANIMALS		
18.3	VEHICLES FOR USE ON WATER AND AMPHIBIOUS VEHICLES		
18.4	ANCHORS, BUOYS, LIFEBELTS		
18.5	AERIAL OR SPACE VEHICLES		
18.7	TRAFFIC SIGNS		
18.1	LAND VEHICLES	18.2	EQUIPMENT FOR ANIMALS
18.1.1	Vehicles propelled by human or animal power (except 18.1.5, 18.1.14 and A 18.1.17 or A 18.1.19)	18.2.1	Horseshoes <u>Note:</u> Including horseshoe-shaped magnets.
A 18.1.2	Chariots for racing or combat, horse-drawn carriages with two wheels	18.2.7	Equipment for horses (except 18.2.1)
A 18.1.3	Horse-drawn carriages or chariots with four or more wheels	A 18.2.9	Stirrups, spurs
18.1.5	Bicycles, motor cycles, motor scooters, tricycles	A 18.2.11	Harness
18.1.7	Motor road vehicles	A 18.2.13	Saddles
A 18.1.8	Lorries, coaches, tractors, trolleybuses	A 18.2.15	Whips, hunting crops
A 18.1.9	Motor cars	18.2.17	Equipment for dogs and cats
18.1.11	Rail vehicles, trains, tramcars	A 18.2.18	Collars and leashes for dogs and cats
A 18.1.12	Locomotives	18.2.25	Equipment for other animals
18.1.14	Other land vehicles		
A 18.1.15	Road rollers, self-propelled road construction or building site vehicles or machines	18.3	VEHICLES FOR USE ON WATER AND AMPHIBIOUS VEHICLES
A 18.1.16	Lifts, lift trucks	18.3.1	Rowing boats, canoes, gondolas, dinghies, kayaks
A 18.1.17	Toboggans, sledges, other vehicles for snow, self-propelled machines for snow	18.3.2	Sailing boats, sailboards
A 18.1.18	Caravans	A 18.3.3	Viking boats, galleys, boats with a single square sail (set on a yard slung horizontally from the mast)
A 18.1.19	Perambulators, caddies, scooters (with or without handlebars)	A 18.3.5	Ancient sailing boats, with a pronounced sheer, and towering superstructures fore and aft
18.1.21	Tyres, tyre prints, snow chains, axles with or without wheels, <u>steering wheels, radiators</u> , shock absorbers of land vehicles <u>Note:</u> Includes also any other parts of land vehicles not classified in another category or division.	A 18.3.7	Large sailing boats on long slender lines, clippers
18.1.23	Stylized land vehicles	A 18.3.9	Other sailing boats
18.1.25	Other means of transport not classified in divisions 18.3 and 18.5 <u>Note:</u> (a) Including cable cars, ski lifts. (b) Not including escalators (7.3.15) and conveyor belts (15.1.7).	A 18.3.10	Sailboards
		A 18.3.13	Mixed ships (sail and steam)
		18.3.14	Motor boats and ships
		A 18.3.15	Liners
		A 18.3.16	Submarines
		A 18.3.17	Other motor boats or vessels, trawlers, tugs <u>Note:</u> Including barges with or without motors.
		A 18.3.18	Ships' funnels
		18.3.21	Sails <u>Note:</u> Includes also any other parts of boats not classified in another category, division or section.

- 18.3.23 Fanciful or stylized boats
- 18.3.25 Other means of transport on water  
Note: Including floating docks,  
 amphibious vehicles and  
 air-cushion vehicles.
  
- 18.4 ANCHORS, BUOYS, LIFE BELTS
  - 18.4.1 Anchors, buoys, lifebelts
  - A 18.4.2 Anchors
  - A 18.4.3 Crossed anchors
  - A 18.4.11 Buoys, lifebelts
  
- 18.5 AERIAL OR SPACE VEHICLES
  - 18.5.1 Aeroplanes, helicopters
  - A 18.5.3 Stylized aeroplanes
  - 18.5.5 Other aerial vehicles
  - A 18.5.6 Balloons, captive balloons, dirigible  
 ballons
  - A 18.5.7 Kites, delta-wing gliders
  - A 18.5.8 Parachutes
  - 18.5.10 Space rockets and capsules, artificial  
 satellites
  
- 18.7 TRAFFIC SIGNS
  - 18.7.1 Road or railway traffic signs
  - A 18.7.9 Direction indicator boards or posts
  - A 18.7.11 Road or railway traffic lights
  - A 18.7.13 Milestones
  - A 18.7.19 Semaphores
  - A 18.7.20 Other road or railway traffic signs
  - 18.7.22 Water or air traffic signs
  - A 18.7.23 Signal buoys
  - A 18.7.25 Other water or air traffic signs

19.	<b>CONTAINERS AND PACKING, REPRESENTATIONS OF MISCELLANEOUS PRODUCTS</b>	
19.1	LARGE CONTAINERS	
19.3	SMALL CONTAINERS	
19.7	BOTTLES, FLASKS	
19.8	PARTS OR ACCESSORIES OF BOTTLES	
19.9	AMPHORAE, PITCHERS, VASES, FLOWER POTS, FLOWER STANDS	
19.11	RECEPTACLES FOR LABORATORY USE AND FOR PHARMACY	
19.13	MEDICAL OR SURGICAL APPARATUS, INSTRUMENTS OR UTENSILS, PROSTHESES, MEDICINES	
19.19	REPRESENTATIONS OF MISCELLANEOUS PRODUCTS	
19.1	LARGE CONTAINERS	19.7 BOTTLES, FLASKS
	<u>Note:</u> Not including containers classified in 19.9.	19.7.1 Bottles or flasks in circular or elliptical horizontal cross section
19.1.1	Large cylindrical containers (such as tanks, gas bottles, barrels)	19.7.2 Bottles or flasks in horizontal cross section other than circular or elliptical
19.1.3	Large non-cylindrical containers (such as packing cases, crates)	19.7.6 Bottles or flasks representing a human being, an animal, part of a human body or of an animal's body, or an inanimate object
19.1.4	Tins and cans, pails <u>Note:</u> Not including hermetically sealed tins (19.3.1 or 19.3.3).	19.7.7 Bottles or flasks with handle
A 19.1.5	Barrels lying horizontally	A 19.7.9 Bottles or flasks, slender
A 19.1.6	Barrels standing upright	A 19.7.10 Bottles or flasks, squat
A 19.1.7	Barrels viewed from the front	A 19.7.12 Bottles or flasks without neck
A 19.1.8	Vats, wooden buckets, milking pails	A 19.7.13 Bottles or flasks with sloping or horizontal neck
A 19.1.11	Large sacks for transporting merchandise	A 19.7.16 Bottles or flasks with inward-curving sides
A 19.1.12	Baskets, including baskets carried on the back (dossers)	A 19.7.17 Bottles or flasks with bulging, protruding or rounded sides
A 19.1.25	Other large containers	A 19.7.20 Bottles or flasks of conical shape
19.3.	SMALL CONTAINERS	A 19.7.22 Bottles or flasks with vertical, horizontal or other ribs
	<u>Note:</u> Not including containers classified in 11.3, 19.7, 19.9 or 19.11.	A 19.7.23 Bottles or flasks with surface relief other than ribs
19.3.1	Small cylindrical containers (such as tubes for pills or for lipsticks, pots for cosmetic cream, preserve tins, jars)	A 19.7.24 Bottles or flasks in wicker casing
19.3.3	Small non-cylindrical containers	19.7.25 Other bottles or flasks
A 19.3.4	Letter boxes	
A 19.3.5	Sachets	
A 19.3.9	Small open containers	
A 19.3.15	Tubes or bottles with their wrappers	
A 19.3.21	Tubes pinched at one end	
A 19.3.25	Other small containers	

LIST OF CATEGORIES, DIVISIONS AND SECTIONS, WITH EXPLANATORY NOTES

19.8	PARTS OR ACCESSORIES OF BOTTLES	19.13	MEDICAL OR SURGICAL APPARATUS, INSTRUMENTS OR UTENSILS, PROSTHESES, MEDICINES
19.8.1	Parts or accessories of bottles <u>Note:</u> (a) Including pouring devices and teats for babies' bottles. (b) Not including bottle openers and corkscrews (11.1.10 and A 11.1.14).	19.13.1	Medical or surgical apparatus, instruments or utensils, prostheses, medicines
A 19.8.2	Bottle necks	A 19.13.3	Hypodermic syringes
A 19.8.5	Stoppers	A 19.13.5	Massage apparatus
A 19.8.7	Sealing capsules	A 19.13.7	Prostheses
A 19.8.25	Other parts or accessories of bottles	A 19.13.15	Plasters, bandages
19.9	AMPHORAE, PITCHERS, VASES, FLOWER POTS, FLOWER STANDS	A 19.13.21	Phials, capsules, pills, tablets, suppositories
19.9.1	Amphorae, pitchers, vases, flower pots, flower stands	A 19.13.25	Other medical or surgical apparatus, instruments or utensils
A 19.9.2	Amphorae with or without handles, pitchers	19.19	REPRESENTATIONS OF MISCELLANEOUS PRODUCTS
A 19.9.3	Flower vases, decorative vases		<u>Note:</u> Includes all representations of products not classified in other categories, divisions and sections.
A 19.9.7	Flower pots or plant-growing pots		
A 19.9.9	Flower stands, plant boxes		
19.11	RECEPTACLES FOR LABORATORY USE AND FOR PHARMACY		
19.11.1	Mortars <u>Note:</u> Including mortars for kitchen use.		
19.11.4	Receptacles for laboratory use and for pharmacy		
A 19.11.5	Retorts, spherical or ovoid		
A 19.11.7	Triangular retorts		
A 19.11.9	Receptacles of spherical shape (balloon flasks)		
A 19.11.11	Receptacles of triangular shape		
A 19.11.13	Test tubes		
A 19.11.25	Other receptacles for laboratory use and for pharmacy		

20.	<b>WRITING, DRAWING OR PAINTING MATERIALS, OFFICE REQUISITES, STATIONERY AND BOOKSELLERS' GOODS</b>		
20.1	WRITING, DRAWING OR PAINTING MATERIALS, SMALL OFFICE REQUISITES		
20.5	PAPERS, DOCUMENTS		
20.7	BOOKS, BOOKBINDINGS, NEWSPAPERS		
20.1	WRITING, DRAWING OR PAINTING MATERIALS, SMALL OFFICE REQUISITES	20.5	PAPERS, DOCUMENTS
20.1.1	Writing drawing or painting materials (except 20.1.15 and 20.1.17)	20.5.1	Parchments with furled or fringed edges
A 20.1.3	Pencils, pens, pen nibs, fountain pens, felt-tip pens	20.5.5	Other documents bearing handwritten or printed texts, or tables
A 20.1.5	Paint brushes	20.5.7	Plans, schematic drawings, diagrams, curves, outlines
A 20.1.9	Painters' rollers	20.5.11	Cards, card indexes, punched cards or tapes
A 20.1.11	Other writing, drawing or painting materials <u>Note:</u> Not including paint sprayguns (15.1.21).	20.5.13	Envelopes
20.1.15	Artists' easels, drawing boards, blackboards, slates	20.5.14	Visiting cards
20.1.16	Clapperboards	20.5.15	Tie-on labels
20.1.17	Other small office requisites <u>Note:</u> (a) Includes in particular paper clips, pencil sharpeners, adhesive tape dispensers, inking pads. (b) Not including drawing pins (14.3.1 and A 14.3.3) and office requisites classified in 17.5.1 and A 17.5.2, A 17.5.3, A 17.5.7 and A 17.5.9 and in division 20.5.	20.5.16	Identification cards, magnetic or not
		20.5.21	Postage stamps
		20.5.23	Bank notes
		20.5.25	Paper in rolls, wallpaper, other papers and documents
		20.7	BOOKS, BOOKBINDINGS, NEWSPAPERS
		20.7.1	Books, magazines, newspapers, bookbindings, binders
		A 20.7.2	Books, magazines, newspapers
		A 20.7.5	Bookbindings, binders
A 20.1.19	Embossed stamps or rubber stamps	A 20.7.7	Headings of newspapers or magazines

21. GAMES, TOYS, SPORTING ARTICLES, ROUNDABOUTS
- 21.1 GAMES, TOYS
- 21.3 SPORTING ARTICLES, ROUNDABOUTS
- 21.1 GAMES, TOYS
- 21.1.1 Packs of cards, playing card, figures on playing cards  
Note: Hearts and clubs will be placed in 2.9.1 and 5.3.6 respectively.
- A 21.1.2 Spade (suit)
- A 21.1.3 Diamond (suit)
- A 21.1.4 Four suits together (heart, spade, diamond, club)
- A 21.1.5 Figures of King, Queen or Jack
- A 21.1.7 Packs of cards, playing cards
- 21.1.9 Playing dice, dominoes
- 21.1.11 Draughtboards, chessboards, crosswords  
Note: Not including backgrounds in check pattern (25.7.1 and A 25.7.4).
- 21.1.13 Chessmen
- 21.1.14 Puzzles and their constitutive elements
- 21.1.15 Building games, pieces for building games
- 21.1.25 Other games or toys
- 21.3 SPORTING ARTICLES, ROUNDABOUTS
- 21.3.1 Footballs and other balls, shuttlecocks
- 21.3.3 Skittles
- 21.3.5 Rackets
- 21.3.7 Golf clubs, hockey sticks
- 21.3.9 Skis, points of skis, ski sticks
- 21.3.11 Ice or roller skates
- 21.3.13 Dumb-bells, weights for lifting
- 21.3.15 Tackle for fishing and hunting (except 21.3.16)  
Note: (a) Including tackle for underwater fishing.  
 (b) Not including arms classified in divisions 23.1 and 23.3.
- 21.3.16 Nets for fishing, hunting or games
- 21.3.17 Goals for football and other team sports
- 21.3.19 Roundabouts, chutes, swings, seesaws
- 21.3.21 Targets
- 21.3.23 Boxing gloves
- 21.3.25 Other sporting articles  
Note: (a) Including gymnastic apparatus and instruments.  
 (b) Not including ice-axes (14.9.5), bows (23.1.5), arrows, which are classified in division 24.15, javelins (23.1.1), sailboards (18.3.2 and A 18.3.10).



LIST OF CATEGORIES, DIVISIONS AND SECTIONS, WITH EXPLANATORY NOTES

22.	<b>MUSICAL INSTRUMENTS AND THEIR ACCESSORIES, MUSIC ACCESSORIES, BELLS, PICTURES, SCULPTURES</b>		
22.1	MUSICAL INSTRUMENTS, MUSICAL INSTRUMENT ACCESSORIES, MUSIC ACCESSORIES		
22.3	BELLS		
22.5	PICTURES, SCULPTURES		
22.1	MUSICAL INSTRUMENTS, MUSICAL INSTRUMENT ACCESSORIES, MUSIC ACCESSORIES	22.5	PICTURES, SCULPTURES
22.1.1	Percussion instruments <u>Note:</u> Not including bells, which are classified in division 22.3.	22.5.1	Pictures
22.1.5	Wind instruments, whistles	A 22.5.3	Famous pictures
A 22.1.6	Brass instruments (except A 22.1.7)	22.5.10	Sculptures representing human beings
A 22.1.7	Hunting horns	A 22.5.12	Sculptures representing a woman
A 22.1.8	Woodwind instruments, bagpipes	A 22.5.13	Sculptures representing a man
22.1.10	Keyboard instruments <u>Note:</u> Not including accordions (22.1.25).	A 22.5.14	Sculptures representing a child
A 22.1.11	Pipe organs	A 22.5.15	Sculptures representing a group of human beings
22.1.15	Stringed instruments	A 22.5.17	Equestrian sculptures
A 22.1.16	Lyres, harps	22.5.19	Sculptures representing animals
22.1.21	Musical instrument accessories, music accessories <u>Note:</u> Including in particular drumsticks, bows, tuning forks, metronomes, instrument holders, music stands, special cases for musical instruments and batons (for orchestra conductors).	22.5.25	Other sculptures <u>Note:</u> Including abstract sculptures.
A 22.1.22	Tuning forks		
22.1.25	Other musical instruments		
22.3	BELLS		
22.3.1	Bells		
A 22.3.5	One bell		
A 22.3.6	Two bells		
A 22.3.7	Three bells		
A 22.3.8	More than three bells		
A 22.3.21	Small globular bells		

- 23. ARMS, AMMUNITION, ARMOUR
  - Note: Not including military tanks (18.1.14), military aircraft (18.5.1) and warships, which are classified in division 18.3.
  - 23.1 SIDE ARMS, OTHER WEAPONS NOT BEING FIREARMS
    - 23.3 FIREARMS, AMMUNITION, EXPLOSIVES
    - 23.5 ARMOUR
  - 23.1 SIDE ARMS, OTHER WEAPONS NOT BEING FIREARMS
    - 23.1.1 Side arms
      - Note: Not including battle-axes (14.7.2).
    - 23.1.5 Bows, quivers
      - Note: Arrows are classified in division 24.15.
    - 23.1.7 Crossbows
      - Note: Arrows are classified in division 24.15.
    - 23.1.25 Other weapons not being firearms
      - Note: Includes in particular clubs, truncheons, boomerangs, catapults.
  - 23.3 FIREARMS, AMMUNITION, EXPLOSIVES
    - 23.3.1 Firearms
    - A 23.3.2 Cannons, self-propelled cannons, rocket launchers
    - A 23.3.3 Rifles, sub-machine guns, machine guns
    - A 23.3.5 Pistols, revolvers
    - A 23.3.7 Other firearms
    - 23.3.10 Ammunition, explosives
    - A 23.3.11 Lead-shot cartridges
    - A 23.3.13 Ball cartridges
    - A 23.3.15 Shells, rockets
    - A 23.3.17 Grenades
    - A 23.3.25 Other ammunition or explosives
  - 23.5 ARMOUR
    - 23.5.1 Armour
      - A 23.5.5 Helmets being parts of armour
      - A 23.5.11 Other parts of armour

24.	HERALDRY, COINS, EMBLEMS, SYMBOLS		
24.1	SHIELDS		
24.3	SEALS, STAMPS		
24.5	MEDALS, COINS, DECORATIONS, ORDERS		
24.7	FLAGS		
24.9	CROWNS, DIADEMS		
24.11	EMBLEMS, INSIGNIA		
24.13	CROSSES		
24.15	ARROWS		
24.17	SIGNS, NOTATIONS, SYMBOLS		
24.1	SHIELDS	24.3	SEALS, STAMPS
24.1.1	Shields containing neither a figurative element nor an inscription	24.3.1	Seals or stamps
24.1.3	Shields containing representations of geometrical figures or solids, lines, bands or partitions	A 24.3.2	Seals or stamps attached or applied to a document, ribbon or other object
24.1.5	Shields containing other figurative elements or inscriptions	A 24.3.7	Seals or stamps, circular
A 24.1.7	Shields containing representations of heavenly bodies or natural phenomena	A 24.3.8	Seals or stamps, elliptical
A 24.1.8	Shields containing representations of human beings or parts of the human body, with or without armour	A 24.3.9	Seals or stamps having some other form
A 24.1.9	Shields containing representations of animals or parts of animals' bodies	A 24.3.11	Seals or stamps with representations of heavenly bodies or natural phenomena
A 24.1.10	Shields containing representations of plants	A 24.3.12	Seals or stamps with representations of human beings or parts of the human body
A 24.1.11	Shields containing representations of landscapes, dwellings, buildings or structural works	A 24.3.13	Seals or stamps with representations of animals or parts of animals' bodies
A 24.1.12	Shields containing representations of manufactured or industrial articles	A 24.3.14	Seals or stamps with representations of plants
A 24.1.13	Shields containing other figurative elements	A 24.3.15	Seals or stamps with representations of landscapes, dwellings, buildings or structural works
A 24.1.15	Shields containing inscriptions	A 24.3.16	Seals or stamps with representations of manufactured or industrial articles
24.1.17	Shields with figurative elements or inscriptions placed outside	A 24.3.17	Seals or stamps with representations of geometrical figures or solids
A 24.1.18	Shields surmounted by figurative elements or inscriptions	A 24.3.18	Seals or stamps with inscriptions
A 24.1.19	Shields with supporters	A 24.3.19	Seals or stamps with other figurative elements
A 24.1.20	Shields with figurative elements or inscriptions placed outside in any other way		
24.1.23	Several shields		
24.1.25	Shields of unusual shape		

24.5	MEDALS, COINS, DECORATIONS, ORDERS	A 24.9.20	Crowns with representations of human beings or parts of the human body
24.5.1	One medal or coin	A 24.9.21	Crowns with representations of animals or parts of animals' bodies
A 24.5.2	One medal or coin with the representation of a human head or a human being	A 24.9.22	Crowns with representations of plants
A 24.5.3	One medal or coin with some other figurative element	A 24.9.23	Crowns with representations of manufactured or industrial articles
24.5.5	Two medals or coins	A 24.9.24	Crowns with another figurative element
24.5.7	More than two medals or coins	A 24.9.25	Crowns presenting other characteristics
24.5.20	Decorations, orders		
A 24.5.21	Golden fleece	24.11	EMBLEMS, INSIGNIA
A 24.5.25	Other decorations or orders	24.11.1	Roman ensigns, lictors' fasces, sceptres
24.7	FLAGS	24.11.3	Staves with wings (Mercury's staff)
24.7.1	One flag	24.11.5	Crooked sticks, shepherds' crooks, pastoral staffs
24.7.3	Two or more flags	24.11.7	Neptune's tridents
A 24.7.5	Flags in clusters	24.11.11	Globes surmounted by a cross
A 24.7.11	Flags in the form of a banderole	24.11.13	Mitres
A 24.7.13	Flags of which the part farthest from the staff is rounded or tapers to a point or swallow tail	24.11.14	Mercury's helmet (with wings)
A 24.7.15	Flags in the form of a triangle	24.11.16	Horns of plenty
A 24.7.21	Several flags on the same flagstaff, on the same cable	24.11.17	Chinese symbol of good luck (Ruyi)
A 24.7.23	Stylized flags	24.11.21	Braid (as decoration of honour or rank) <u>Note:</u> Not including chevrons, which will be placed in the same section as angles (26.3.23).
24.9	CROWNS, DIADEMS	24.11.25	Other emblems or insignia <u>Note:</u> Not including representations of the serpent and cup (3.11.1 and A 3.11.2), the serpent and staff (3.11.1 and A 3.11.3), imperial eagles (3.7.1 and A 3.7.2), and torches (13.1.5).
24.9.1	Crowns closed at the top (by cap of estate or chapeau)	24.13	CROSSES
24.9.2	Crowns open at the top	24.13.1	Greek cross, St. Andrew's cross
24.9.3	Stylized or fanciful crowns	24.13.2	Latin cross, tau cross
24.9.4	Diadems	24.13.3	Cross of Lorraine, Papal cross
A 24.9.5	One crown	24.13.4	Maltese cross
A 24.9.6	Two or more crowns	24.13.5	Crosses formed by inscriptions
A 24.9.7	Crowns with spheres on the tips of the points	A 24.13.9	Crosses formed by intersecting lines
A 24.9.8	Crowns having the upper rim indented to resemble towers or battlements	A 24.13.13	Crosses containing an inscription
A 24.9.9	Crowns having three triangular points	A 24.13.14	Crosses accompanied by an inscription
A 24.9.10	Crowns having more than three triangular points	A 24.13.17	Crosses containing a figurative element
A 24.9.11	Crowns with points in the form of arrows	A 24.13.21	Crosses with rays or radiating lines
A 24.9.12	Crowns with foliage dominant	A 24.13.22	Crosses within a circle or a polygon
A 24.9.14	Crowns accompanied by a letter, monogram or numeral(s)	A 24.13.23	Crosses within a square or a rectangle
A 24.9.16	Crowns accompanied by another inscription	A 24.13.24	Crosses within any other figurative element
		24.13.25	Other crosses

- 24.15      ARROWS
- 24.15.1    One arrow
- 24.15.2    Two arrows
- 24.15.3    More than two arrows
- .....
- A 24.15.5    Arrows with barbs
- A 24.15.7    Arrows combined with a letter,  
monogram or numeral(s)
- A 24.15.8    Arrows combined with any other  
inscription (except A 24.15.17)
- A 24.15.11    Arrows combined with any other  
figurative element (except A 24.15.13  
and A 24.15.15)
- A 24.15.13    Arrows forming a circle, an arc of a  
circle or a ring
- A 24.15.15    Arrows forming any other geometrical  
figure
- A 24.15.17    Arrows formed by an inscription
- 24.15.21    Arrowheads  
Note: Not including arrowheads in the  
form of angles (26.3.23).
- .....
- 24.17      SIGNS, NOTATIONS, SYMBOLS
- 24.17.1    Punctuation marks
- A 24.17.2    Dots
- 24.17.3    Asterisks
- .....
- 24.17.5    Mathematical signs
- A 24.17.6    Several mathematical signs
- A 24.17.7    Mathematical signs combined with  
figures or letters
- A 24.17.8    Symbol of infinity
- A 24.17.9    Other mathematical symbols
- 24.17.10    Musical symbols
- A 24.17.11    Treble clefs alone
- A 24.17.12    Notes alone
- A 24.17.13    Treble clefs with notes and stave or  
with stave alone
- A 24.17.14    Other musical symbols
- 24.17.15    Astronomical or astrological signs,  
signs of the zodiac, signs for  
masculine or feminine
- .....
- 24.17.21    Yin and yang symbol
- .....
- 24.17.25    Other signs, notations or symbols

25.	<b>ORNAMENTAL MOTIFS, SURFACES OR BACKGROUNDS WITH ORNAMENTS</b>		
25.1	ORNAMENTAL MOTIFS		
25.3	HORIZONTALLY ELONGATED ORNAMENTAL SURFACES		
25.5	BACKGROUNDS DIVIDED INTO TWO OR FOUR		
25.7	SURFACES OR BACKGROUNDS COVERED WITH REPEATED FIGURATIVE ELEMENTS OR INSCRIPTIONS		
25.12	SURFACES OR BACKGROUNDS COVERED WITH OTHER ORNAMENTS		
25.1	ORNAMENTAL MOTIFS	A 25.3.7	Elongated surfaces with entasis on one or two long sides
	<u>Note:</u> Not including ornamental motifs composed of plants, which are classified in division 5.13, or horizontally elongated ornamental surfaces, which are classified in division 25.3.	A 25.3.9	Elongated polygons <u>Note:</u> Not including triangles, which are classified in division 26.3, or quadrilaterals, which are classified in division 26.4.
25.1.1	Frontispieces (as a title page or on a label)	A 25.3.11	Elongated surfaces with one or two long sides concave
25.1.5	Ornamental bands and borders (except 25.1.9)	A 25.3.13	Elongated surfaces with one or two long sides convex
25.1.6	Banderoles, cartouches	A 25.3.15	Elongated surfaces with one or more sides consisting of a series of arcs of circles or ellipses
25.1.9	Framework and frames		
A 25.1.10	Complete framework and frames	A 25.3.25	Other elongated surfaces
A 25.1.13	Partial frames, embellishments		
25.1.15	Labels, collarettes (bottle-neck labels) <u>Note:</u> Not including tie-on labels (20.5.15).	25.5	BACKGROUNDS DIVIDED INTO TWO OR FOUR <u>Note:</u> Includes backgrounds divided into two or four by lines or bands or by areas of different appearance.
A 25.1.17	Bottle collarettes (bottle-neck labels)	25.5.1	Backgrounds divided into two, vertically
A 25.1.18	Labels in the form of bands or rings	25.5.2	Backgrounds divided into two, horizontally
A 25.1.19	Other labels	25.5.3	Backgrounds divided into two, diagonally
25.1.25	Other ornamental motifs	25.5.5	Backgrounds divided crosswise, vertically and horizontally
25.3	HORIZONTALLY ELONGATED ORNAMENTAL SURFACES	25.5.6	Backgrounds divided crosswise, diagonally
	<u>Note:</u> Not including elongated elliptical surfaces, which are classified in division 26.1, elongated triangular surfaces, which are classified in division 26.3, or elongated quadrilateral surfaces, which are classified in division 26.4.	25.5.25	Other backgrounds divided into two or four
25.3.1	Horizontally elongated surfaces		
A 25.3.3	Elongated surfaces with two short sides convex or concave		
A 25.3.5	Elongated surfaces with one short side convex or concave		

- 25.7 SURFACES OR BACKGROUNDS COVERED WITH REPEATED FIGURATIVE ELEMENTS OR INSCRIPTIONS
- 25.7.1 Surfaces or backgrounds covered with repeated geometrical figures or designs
- A 25.7.2 Surfaces or backgrounds covered with lozenge shapes
- A 25.7.3 Surfaces or backgrounds covered with squares or rectangles (except A 25.7.4)
- A 25.7.4 Surfaces or backgrounds in check pattern
- A 25.7.5 Surfaces or backgrounds covered with polygons
- A 25.7.6 Surfaces or backgrounds covered with circles or ellipses
- A 25.7.7 Surfaces or backgrounds covered with dots
- A 25.7.8 Surfaces or backgrounds covered with other repeated geometrical figures or designs
- 25.7.15 Surfaces or backgrounds covered with hatching
- 25.7.17 Surfaces or backgrounds covered with a repeated inscription
- 25.7.20 Surfaces or backgrounds covered with lines or bands
- A 25.7.21 Surfaces or backgrounds covered with straight lines or bands
- A 25.7.22 Surfaces or backgrounds covered with wavy lines or bands
- A 25.7.23 Surfaces or backgrounds covered with lines or bands in zigzag or chevron pattern
- 25.7.25 Surfaces or backgrounds covered with other repeated figurative elements  
Note: Not including surfaces covered with scattered leaves (5.3.16) or scattered flowers (5.5.23).
- 25.12 SURFACES OR BACKGROUNDS COVERED WITH OTHER ORNAMENTS
- 25.12.1 Surfaces or backgrounds covered with rays or radiating lines
- 25.12.3 Moiré surfaces or backgrounds
- 25.12.25 Surfaces or backgrounds covered with any other ornament

26. GEOMETRICAL FIGURES AND SOLIDS

Note: (a) Including geometrical figures and solids composed of human beings, animals, plants or objects.  
 (b) Not including inscriptions forming geometrical figures, which are classified in division 27.1.

- 26.1 CIRCLES, ELLIPSES
- 26.2 SEGMENTS OR SECTORS OF CIRCLES OR ELLIPSES
- 26.3 TRIANGLES, LINES FORMING AN ANGLE
- 26.4 QUADRILATERALS
- 26.5 OTHER POLYGONS
- 26.7 DIFFERENT GEOMETRICAL FIGURES, JUXTAPOSED, JOINED OR INTERSECTING
- 26.11 LINES, BANDS
- 26.13 OTHER GEOMETRICAL FIGURES, INDEFINABLE DESIGNS
- 26.15 GEOMETRICAL SOLIDS

		A 26.1.21	Circles or ellipses containing inscriptions arranged in circular or elliptical form
26.1	CIRCLES, ELLIPSES	A 26.1.22	Circles or ellipses containing inscriptions arranged in some other form
26.1.1	Circles		
26.1.2	Ellipses		
A 26.1.3	One circle or ellipse	A 26.1.24	Circles or ellipses with dark surfaces or parts of surfaces
26.1.4	Two circles, two ellipses, one inside the other	. . .	
26.1.5	More than two circles or ellipses, inside one another, spirals		
26.1.6	Several circles or ellipses, juxtaposed, tangential or intersecting	26.2	SEGMENTS OR SECTORS OF CIRCLES OR ELLIPSES
26.1.7	Circles containing one or more ellipses	26.2.1	Segments of circles or ellipses (except 26.2.7)
26.1.8	Circles containing one or more polygons (except 26.1.10 and 26.1.11)	26.2.3	Sectors of circles or ellipses (except 26.2.7)
26.1.9	Ellipses containing one or more circles or polygons (except 26.1.10 and 26.1.11)	26.2.5	Joined or intersecting segments or sectors of circles or ellipses
26.1.10	Circles or ellipses containing one or more triangles or lines forming an angle	26.2.7	Semicircles, semi-ellipses
26.1.11	Circles or ellipses containing one or more quadrilaterals	. . .	
26.1.12	Circles or ellipses containing one or more other geometrical figures	26.3	TRIANGLES, LINES FORMING AN ANGLE
A 26.1.13	Circles or ellipses containing representations of heavenly bodies or natural phenomena	26.3.1	One triangle
A 26.1.14	Circles or ellipses containing representations of human beings or parts of the human body	26.3.2	Two triangles, one inside the other
A 26.1.15	Circles or ellipses containing representations of animals, parts of animals' bodies or plants	26.3.3	More than two triangles, inside one another
A 26.1.16	Circles or ellipses containing other figurative elements	26.3.4	Several triangles, juxtaposed, joined or intersecting
A 26.1.17	Circles or ellipses containing one or more numerals	A 26.3.5	Triangles pointing downwards
A 26.1.18	Circles or ellipses containing one or more letters	A 26.3.6	Triangular figures with one or more convex or concave sides
A 26.1.19	Circles or ellipses with inscriptions projecting beyond the circumference	A 26.3.7	Triangular figures with one or more truncated or rounded angles
A 26.1.20	Circles or ellipses containing inscriptions arranged along the radius or diameter		



LIST OF CATEGORIES, DIVISIONS AND SECTIONS, WITH EXPLANATORY NOTES

26.3.10	Triangles containing one or more circles, ellipses or polygons (except 26.3.11)	A 26.4.14	Quadrilaterals containing representations of human beings or parts of the human body
26.3.11	Triangles containing one or more quadrilaterals	A 26.4.15	Quadrilaterals containing representations of animals or parts of animals' bodies or plants
26.3.12	Triangles containing one or more other geometrical figures	A 26.4.16	Quadrilaterals containing other figurative elements
A 26.3.13	Triangles containing representations of heavenly bodies or natural phenomena	A 26.4.17	Quadrilaterals containing one or more numerals
A 26.3.14	Triangles containing representations of human beings or parts of the human body	A 26.4.18	Quadrilaterals containing one or more letters
A 26.3.15	Triangles containing representations of animals or parts of animals' bodies or plants	A 26.4.19	Quadrilaterals with inscriptions projecting beyond one or more of the sides thereof
A 26.3.16	Triangles containing other figurative elements	A 26.4.22	Quadrilaterals containing other inscriptions
A 26.3.17	Triangles containing one or more numerals	A 26.4.24	Quadrilaterals with dark surfaces or parts of surfaces
A 26.3.18	Triangles containing one or more letters	...	
A 26.3.19	Triangles with inscriptions projecting beyond one or more of the sides thereof		
A 26.3.22	Triangles containing other inscriptions	26.5	OTHER POLYGONS
26.3.23	Lines or bands forming an angle <u>Note:</u> Including chevrons and arrowheads formed by lines or bands.		<u>Note:</u> Not including elongated polygons (25.3.1 and A 25.3.9).
A 26.3.24	Triangles with dark surfaces or parts of surfaces	26.5.1	One polygon
...		26.5.2	Two polygons, one inside the other (except 26.5.10 and 26.5.11)
		26.5.3	Several polygons, inside one another (except 26.5.10 and 26.5.11)
		26.5.4	Several polygons, juxtaposed, joined or intersecting
26.4	QUADRILATERALS	A 26.5.6	Polygonal figures with one or more convex or concave sides
26.4.1	Squares	...	
26.4.2	Rectangles	26.5.9	Polygons containing one or more circles or ellipses
26.4.3	Rhombs or squares standing on one of the corners thereof	26.5.10	Polygons containing one or more triangles or lines forming an angle
26.4.4	Other irregular parallelograms, trapezia and quadrilaterals	26.5.11	Polygons containing one or more quadrilaterals
A 26.4.5	One quadrilateral	26.5.12	Polygons containing one or more other geometrical figures
A 26.4.6	Quadrilateral figures with one or more convex or concave sides <u>Note:</u> Not including elongated surfaces with one or more convex or concave sides (25.3.1, A 25.3.3, A 25.3.5, A 25.3.11, A 25.3.13).	A 26.5.13	Polygons containing representations of heavenly bodies or natural phenomena
26.4.7	Two quadrilaterals, one inside the other	A 26.5.14	Polygons containing representations of human beings or parts of the human body
26.4.8	More than two quadrilaterals, inside one another	A 26.5.15	Polygons containing representations of animals or parts of animals' bodies or plants
26.4.9	Several quadrilaterals juxtaposed, joined or intersecting	A 26.5.16	Polygons containing other figurative elements
26.4.10	Quadrilaterals containing one or more circles, ellipses or polygons	A 26.5.17	Polygons containing one or more numerals
26.4.11	Quadrilaterals containing one or more triangles or lines forming an angle	A 26.5.18	Polygons containing one or more letters
26.4.12	Quadrilaterals containing one or more other geometrical figures	A 26.5.19	Polygons with inscriptions projecting beyond the circumference
A 26.4.13	Quadrilaterals containing representations of heavenly bodies or natural phenomena	A 26.5.22	Polygons containing other inscriptions
		A 26.5.24	Polygons with dark surfaces or parts of surfaces
		...	

26.7	DIFFERENT GEOMETRICAL FIGURES, JUXTAPOSED, JOINED OR INTERSECTING	26.13	OTHER GEOMETRICAL FIGURES, INDEFINABLE DESIGNS
26.7.1	Circles or ellipses with one or more segments and/or sectors of circles or ellipses	26.13.1	Stains, spots, blots
26.7.3	Circles or ellipses with one or more triangles and/or lines forming an angle	26.13.25	Other geometrical figures, indefinable designs
26.7.5	Circles or ellipses with one or more other quadrilaterals	26.15	GEOMETRICAL SOLIDS
26.7.7	Circle or ellipses with one or more other polygons	26.15.1	Spheres
26.7.9	Segments or sectors of circles or ellipses with one or more triangles and/or lines forming an angle	26.15.3	Cylinders
26.7.11	Segments or sectors of circles or ellipses with one or more quadrilaterals	26.15.5	Cones
26.7.13	Segments or sectors of circles or ellipses with one or more other polygons	26.15.7	Pyramids
26.7.15	Triangles or lines forming an angle with one or more quadrilaterals	26.15.9	Cubes
26.7.17	Triangles or lines forming an angle with one or more polygons other than quadrilaterals	26.15.11	Parallelepipeds
26.7.19	Quadrilaterals with one or more polygons other than triangles	26.15.13	Prisms
26.7.25	Other combinations of different geometrical figures, juxtaposed, joined or intersecting <u>Note:</u> Including combinations of more than two different geometrical figures.	26.15.15	Other polyhedrons
		26.15.25	Other geometrical solids
26.11	LINES, BANDS		
	<u>Note:</u> Not including lines or bands forming an angle (26.3.23).		
26.11.1	One line or one band		
26.11.2	Two lines or bands		
26.11.3	More than two lines or two bands		
A 26.11.5	Thin lines		
A 26.11.6	Thick lines, bands		
A 26.11.7	Vertical lines or bands		
A 26.11.8	Horizontal lines or bands		
A 26.11.9	Oblique lines or bands		
A 26.11.10	Straight lines or bands		
A 26.11.11	Broken lines or bands (except A 26.11.13)		
A 26.11.12	Curved lines or bands (except A 26.11.13)		
A 26.11.13	Wavy lines or bands, zigzag lines or bands		
A 26.11.14	Dotted lines or bands		
A 26.11.21	Set of lines evoking speed or propulsion		
A 26.11.25	Other lines or bands		

27. FORMS OF WRITING, NUMERALS
- 27.1 LETTERS OR NUMERALS FORMING GEOMETRICAL FIGURES, WRITTEN OR TYPOGRAPHICAL MATTER IN PERSPECTIVE
- 27.3 LETTERS OR NUMERALS REPRESENTING A HUMAN BEING, AN ANIMAL, A PLANT OR AN OBJECT
- 27.5 LETTERS PRESENTING A SPECIAL FORM OF WRITING
- 27.7 NUMERALS PRESENTING A SPECIAL FORM OF WRITING
- 
- |   |  |
|---|--|
| <p>27.1 LETTERS OR NUMERALS FORMING GEOMETRICAL FIGURES, WRITTEN OR TYPOGRAPHICAL MATTER IN PERSPECTIVE</p> <p><u>Note:</u> Includes both a single letter or a single numeral and a group of letters or a group of numerals.</p> <p>27.1.1 Letters or numerals forming geometrical figures, written or typographical matter in perspective</p> <p>A 27.1.2 Letters or numerals forming a square or a rectangle (surface or periphery)</p> <p>A 27.1.3 Letters or numerals forming any other quadrilateral (surface or periphery)</p> <p>A 27.1.4 Letters or numerals forming any other polygon (surface or periphery)</p> <p>A 27.1.5 Letters or numerals forming a triangle (surface or periphery)</p> <p>A 27.1.6 Letters or numerals forming a circle or a circumference</p> <p>A 27.1.7 Letters or numerals forming an ellipse (surface or periphery)</p> <p>A 27.1.8 Letters or numerals forming a plano-convex figure</p> <p>A 27.1.9 Letters or numerals forming a plano-concave figure</p> <p>A 27.1.10 Letters or numerals forming a biconvex figure</p> <p>A 27.1.11 Letters or numerals forming a biconcave figure</p> <p>A 27.1.12 Letters or numerals forming a figure in the shape of an arc of a circle</p> <p>A 27.1.13 Letters or numerals forming a figure in the shape of a band with one or more wavy or zigzag sides</p> <p>A 27.1.16 Letters or numerals in perspective (decreasing towards the center, towards one extremity or towards both extremities)</p> <p>A 27.1.25 Letters or numerals forming some other geometrical figure</p> | <p>27.3 LETTERS OR NUMERALS REPRESENTING A HUMAN BEING, AN ANIMAL, A PLANT OR AN OBJECT</p> <p><u>Note:</u> (a) Includes also punctuation marks representing a human being, an animal, a plant or an object.<br/>(b) Includes both a single letter, a single numeral or a single punctuation mark and a group of letters, a group of numerals or a group of punctuation marks representing a human being, an animal, a plant or an object.</p> <p>27.3.1 Letters or numerals representing a human being or a part of the human body, an animal or a part of an animal's body, a plant or an object</p> <p>A 27.3.2 Letters or numerals representing a human being or a part of the human body</p> <p>A 27.3.3 Letters or numerals representing an animal or a part of an animal's body</p> <p>A 27.3.11 Letters or numerals representing a plant</p> <p>A 27.3.15 Letters or numerals representing an object</p> |
|---|--|

27.5	LETTERS PRESENTING A SPECIAL FORM OF WRITING	27.7	NUMERALS PRESENTING A SPECIAL FORM OF WRITING
	<u>Note:</u> Includes both one or more letters and a series of letters forming a word.	27.7.1	Numerals presenting a special form of writing
27.5.1	Letters presenting a special form of writing	A 27.7.2	Numerals written in double outline
A 27.5.2	Letters written in double outline	A 27.7.3	Numerals in relief or shaded
A 27.5.3	Letters in relief or shaded	A 27.7.4	Numerals embellished or decorated with a drawing containing inscriptions or composed of a collection of drawings
A 27.5.4	Letters embellished or decorated with a drawing	A 27.7.11	Numerals juxtaposed or joined to a letter or a figurative element
A 27.5.5	Letters containing written or typographical matter	A 27.7.12	Numerals crossed or barred by letters or numerals or a figurative element
A 27.5.6	Letters composed of a collection of drawings	A 27.7.13	Numerals in handwritten or simulated handwritten characters
A 27.5.7	Letters surmounted by a sign of disproportionate size	A 27.7.17	Numerals in heavy characters
	<u>Note:</u> Includes, for instance, a letter "i" surmounted by a disproportionate dot, by a star or a flower.	A 27.7.19	Numerals overlapping or composed of irregular characters or arranged irregularly
A 27.5.8	Letters linked to a figurative element	A 27.7.23	Roman numerals
	<u>Note:</u> Letters representing a human being or a part of the human body, an animal or a part of an animal's body, a plant or an object are classified in division 27.3.	A 27.7.24	Numerals in light-colored characters on a dark background
A 27.5.9	Series of letters presenting different forms of writing	A 27.7.25	Numerals presenting some other special form of writing
A 27.5.10	Series of letters in different dimensions		
A 27.5.11	Letters underlined, overlined, framed or barred by one or more strokes		
A 27.5.12	Letters crossed or barred by letters, numerals or a figurative element		
A 27.5.13	Letters in the form of a signature, illegible signatures		
A 27.5.14	Letters repeated by mirror effect or symmetrically in any position		
A 27.5.15	Series of letters separated from one another other than by a single space		
	<u>Note:</u> Includes a series of letters separated, for instance, by framing, strokes or varying levels.		
A 27.5.17	Letters in heavy characters		
A 27.5.19	Letters overlapping		
A 27.5.21	One letter		
A 27.5.22	Monograms formed of intertwined, overlapping or otherwise combined letters		
A 27.5.23	Several letters		
A 27.5.24	Letters in light-colored characters on a dark background		
A 27.5.25	Letters presenting some other special form of writing		

28. INSCRIPTIONS IN VARIOUS CHARACTERS

Note: Naturally, no account should be taken, in a given country, of the divisions relating to inscriptions in characters normally used in that country. In such cases, the inscriptions constitute word marks.

- 28.1 INSCRIPTIONS IN ARABIC CHARACTERS
- 28.3 INSCRIPTIONS IN CHINESE OR JAPANESE CHARACTERS
- 28.5 INSCRIPTIONS IN CYRILLIC CHARACTERS
- 28.7 INSCRIPTIONS IN GREEK CHARACTERS
- 28.9 INSCRIPTIONS IN HEBREW CHARACTERS
- 28.11 INSCRIPTIONS IN LATIN CHARACTERS
- 28.17 INSCRIPTIONS IN HISTORICAL CHARACTERS
- 28.19 INSCRIPTIONS IN OTHER CHARACTERS

29. COLOURS

29.1 COLOURS

- 29.1.1 Red, pink, orange
- 29.1.2 Yellow, gold
- 29.1.3 Green
- 29.1.4 Blue
- 29.1.5 Violet
- 29.1.6 White, grey, silver
- 29.1.7 Brown
- 29.1.8 Black

- A 29.1.11 One predominant color
- 29.1.12 Two predominant colors
- 29.1.13 Three predominant colors
- 29.1.14 Four colors
- 29.1.15 Five colors and over

## **EXAMPLES OF FIGURATIVE ELEMENTS**



**EXAMPLES OF FIGURATIVE ELEMENTS RELATING  
TO THE FOLLOWING DIVISIONS**

	<u>Page</u>
Division 19.7: Bottles, flasks . . . . .	84
Division 24.1: Shields . . . . .	90
Division 24.9: Crowns, diadems . . . . .	95
Division 24.13: Crosses . . . . .	99



Division 19.7: Bottles, flasks

19.7.1 Bottles or flasks in circular or elliptical horizontal cross section



19.7.2 Bottles or flasks in horizontal cross section other than circular or elliptical

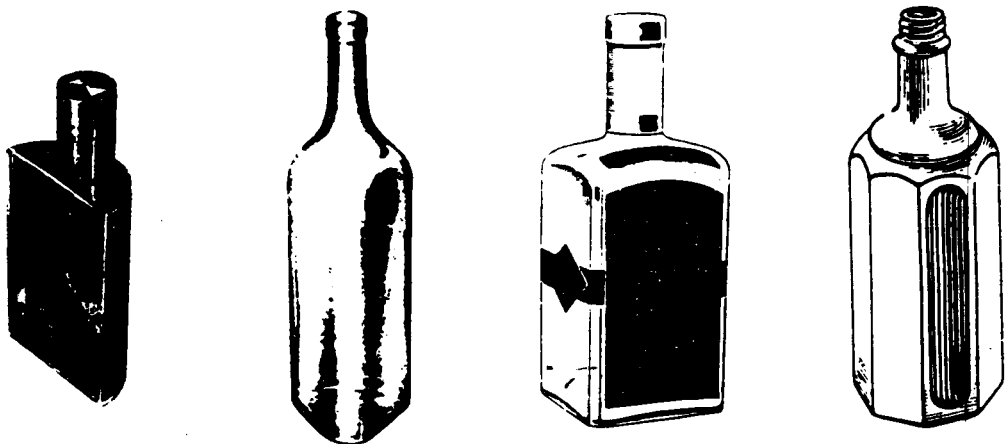

19.7.6 Bottles or flasks representing a human being, an animal, part of a human body or of an animal's body, or an inanimate object



19.7.7 Bottles or flasks with handle

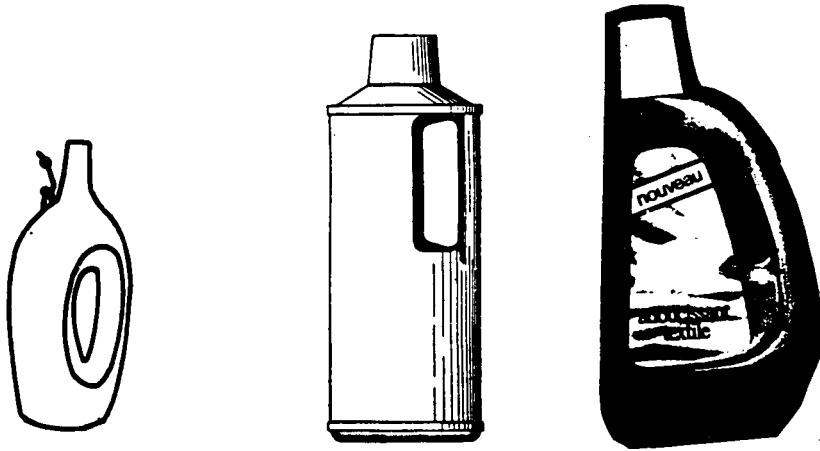

A 19.7.9 Bottles or flasks, slender



A 19.7.10 Bottles or flasks, squat

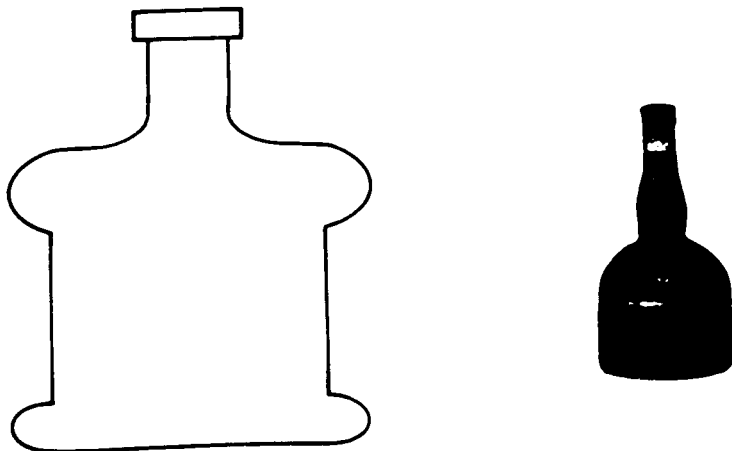

A 19.7.12 Bottles or flasks without neck

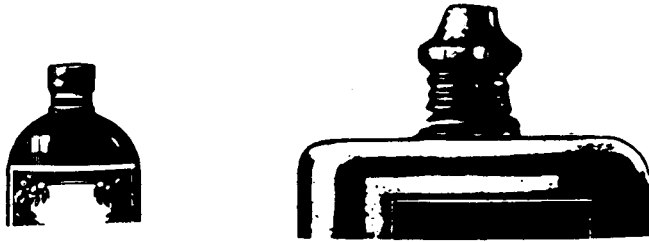

A 19.7.13 Bottles or flasks with sloping or horizontal neck

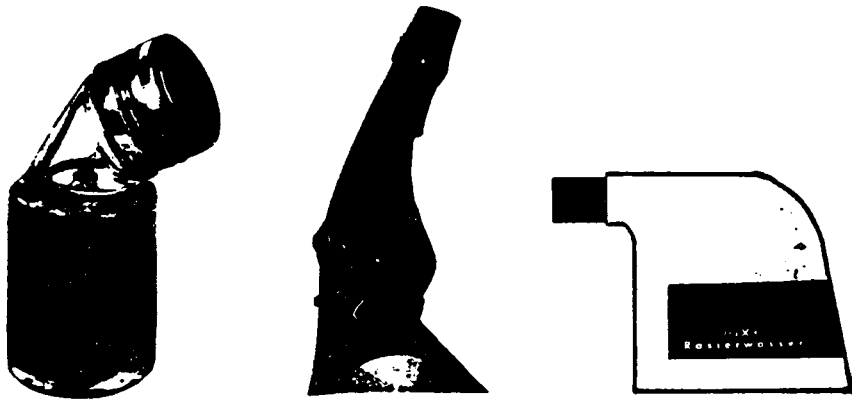

A 19.7.16 Bottles or flasks with inward-curving sides

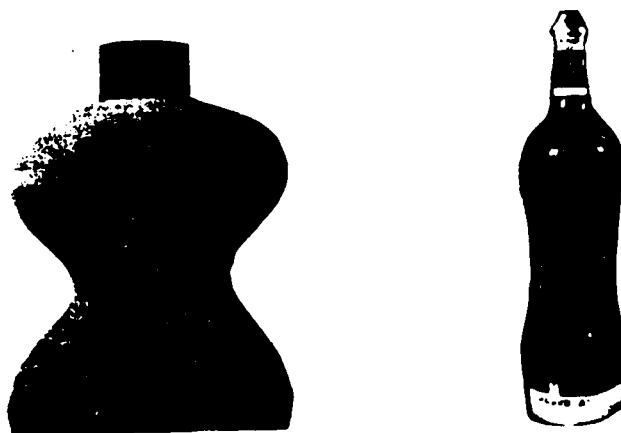

A 19.7.17 Bottles or flasks with bulging, protruding or rounded sides

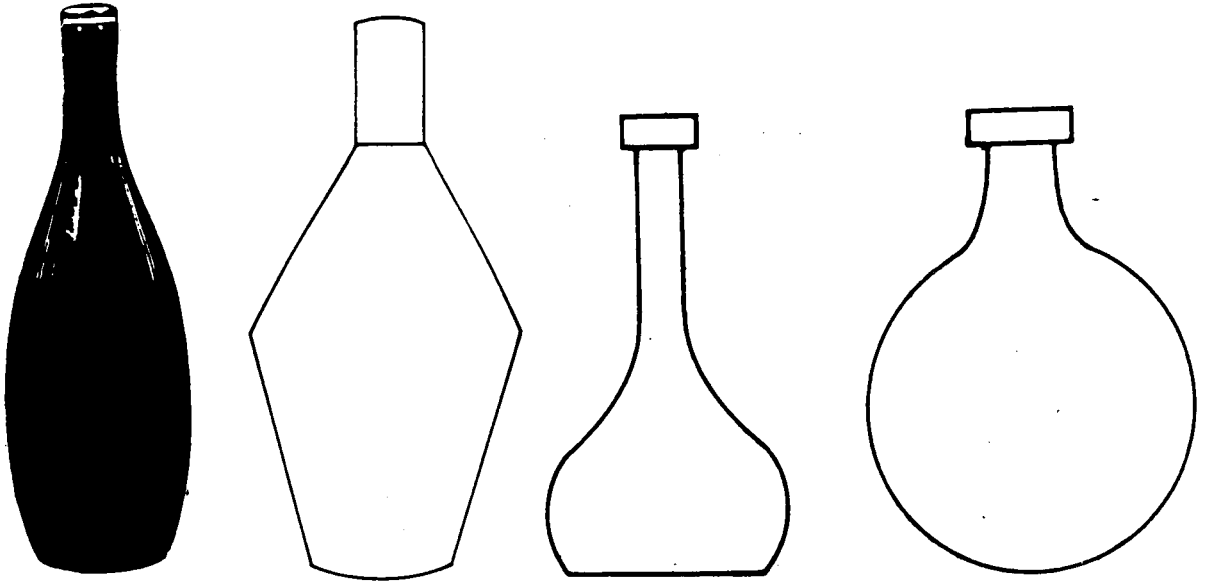

A 19.7.20 Bottles or flasks of conical shape

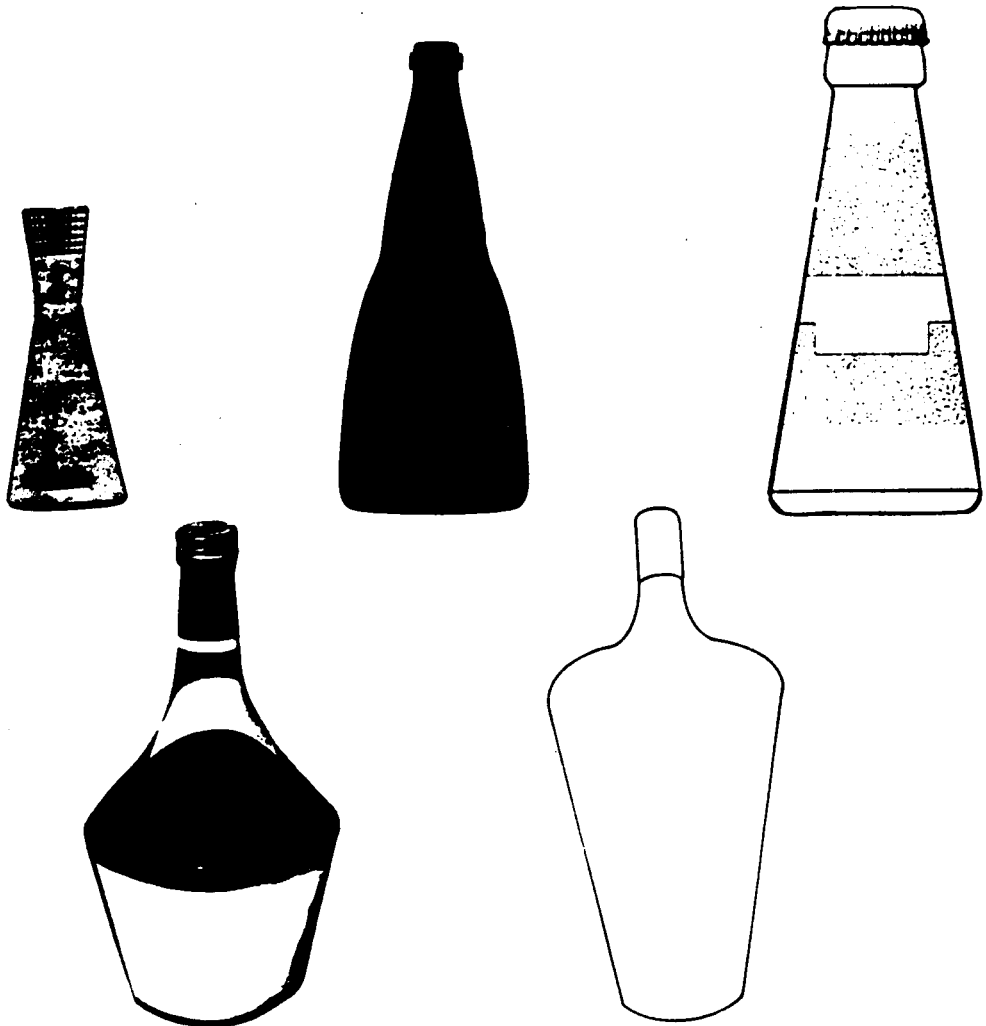

A 19.7.22 Bottles or flasks with vertical, horizontal or other ribs



A 19.7.23 Bottles or flasks with surface relief other than ribs



A 19.7.24 Bottles or flasks in wicker casing

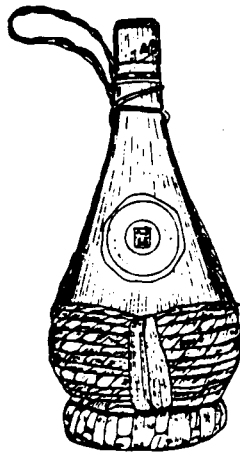

19.7.25 Other bottles or flasks

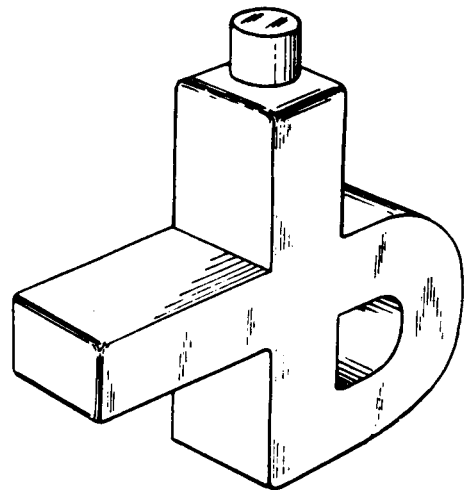
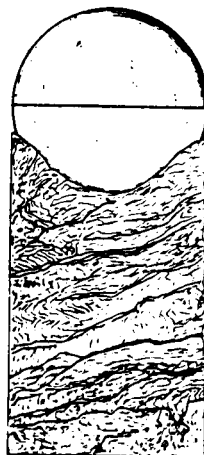
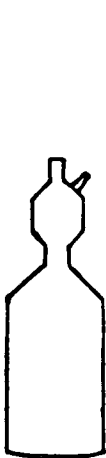
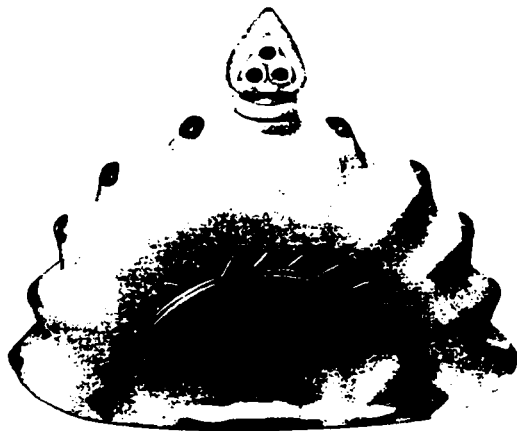
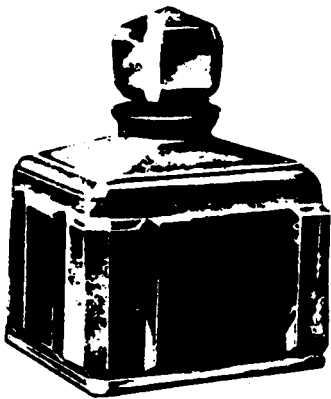

Division 24.1: Shields

24.1.1 Shields containing neither a figurative element nor an inscription



24.1.3 Shields containing representations of geometrical figures or solids, lines, bands or partitions

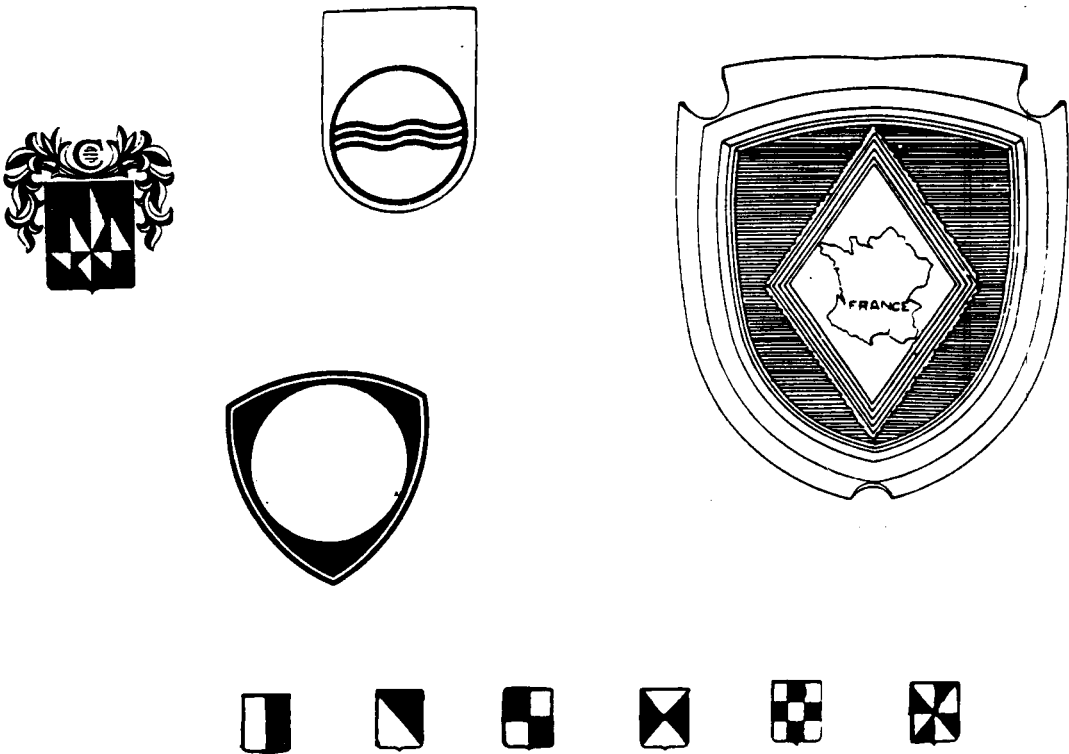

24.1.5 Shields containing other figurative elements or inscriptions  
See auxiliary sections A 24.1.7 to A 24.1.15.

A 24.1.7 Shields containing representations of heavenly bodies or natural phenomena



A 24.1.8 Shields containing representations of human beings or parts of the human body, with or without armour

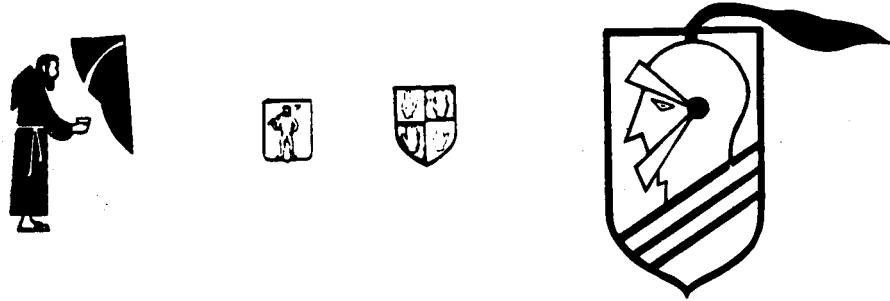

A 24.1.9 Shields containing representations of animals or parts of animals' bodies



A 24.1.10 Shields containing representations of plants



A 24.1.11 Shields containing representations of landscapes, dwellings, buildings or structural works

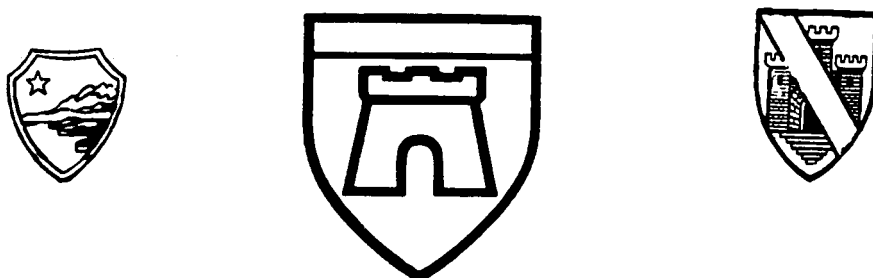



A 24.1.12 Shields containing representations of manufactured or industrial articles

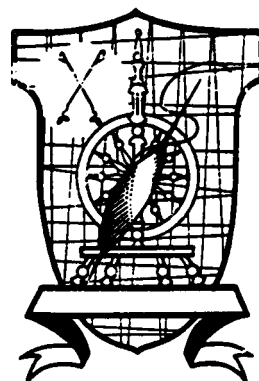
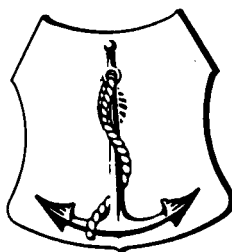

A 24.1.13 Shields containing other figurative elements

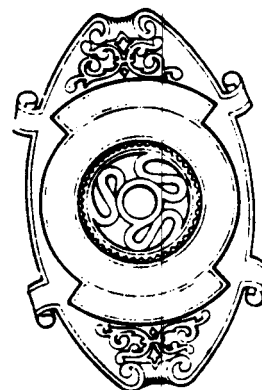
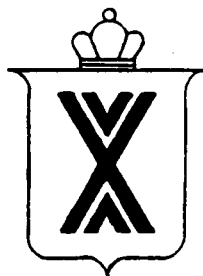
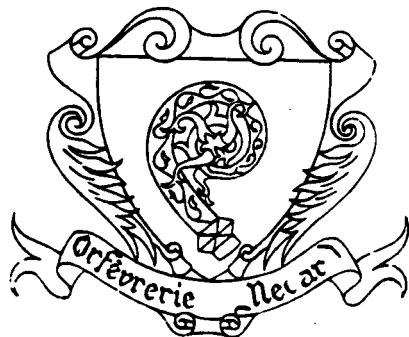

A 24.1.15 Shields containing inscriptions



24.1.17 Shields with figurative elements or inscriptions placed outside

See auxiliary sections A 24.1.18 to A 24.1.20.

A 24.1.18 Shields surmounted by figurative elements or inscriptions

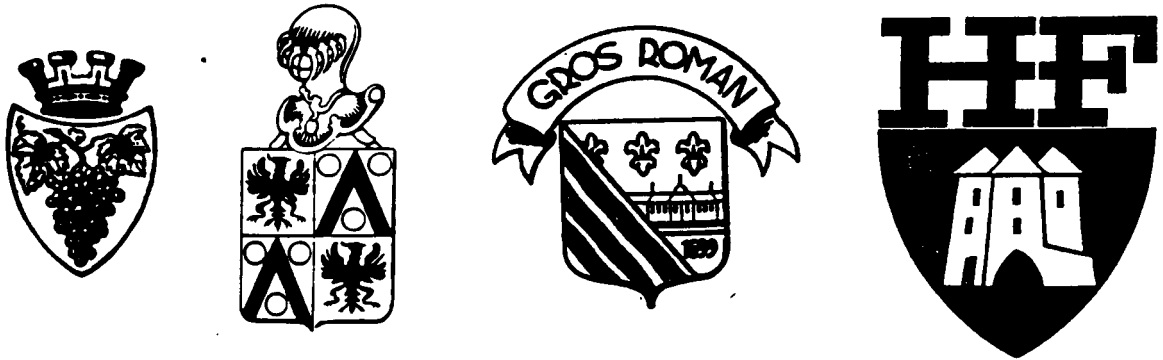

A 24.1.19 Shields with supporters



A 24.1.20 Shields with figurative elements or inscriptions placed outside in any other way

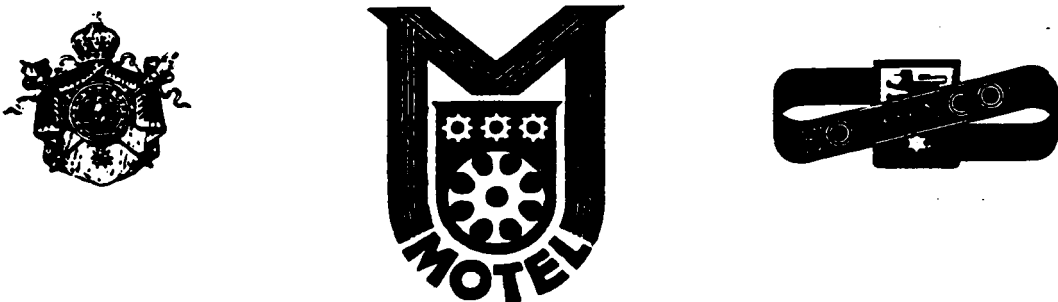

24.1.23 Several shields

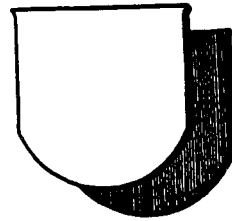
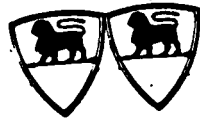

24.1.25 Shields of unusual shape

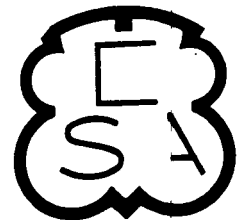
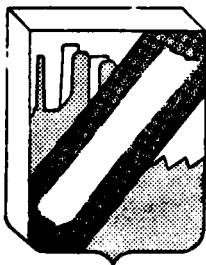
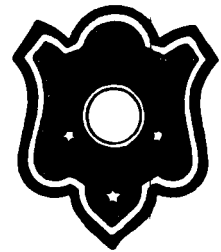

## Division 24.9: Crowns, diadems

24.9.1 Crowns closed at the top (by cap of estate or chapeau)

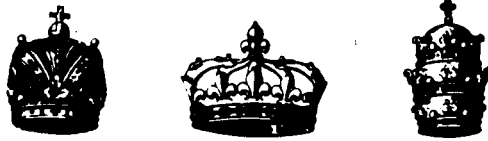

24.9.2 Crowns open at the top



24.9.3 Stylized or fanciful crowns



24.9.4 Diadems



A 24.9.5 One crown  
See different examples ad 24.9.1 to 24.9.3.

A 24.9.6 Two or more crowns  
See different examples ad 24.9.1 to 24.9.3.

A 24.9.7 Crowns with spheres on the tips of the points



A 24.9.8 Crowns having the upper rim indented to resemble towers or battlements



A 24.9.9 Crowns having three triangular points



A 24.9.10 Crowns having more than three triangular points



A 24.9.11 Crowns with points in the form of arrows

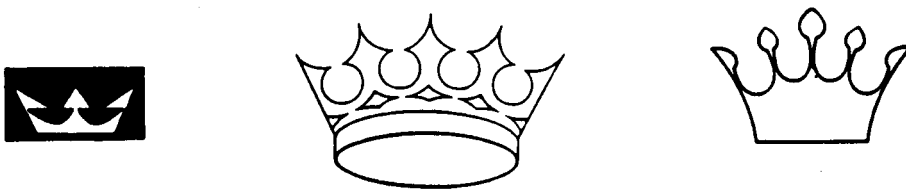

A 24.9.12 Crowns with foliage dominant



A 24.9.14 Crowns accompanied by a letter, monogram or numerals

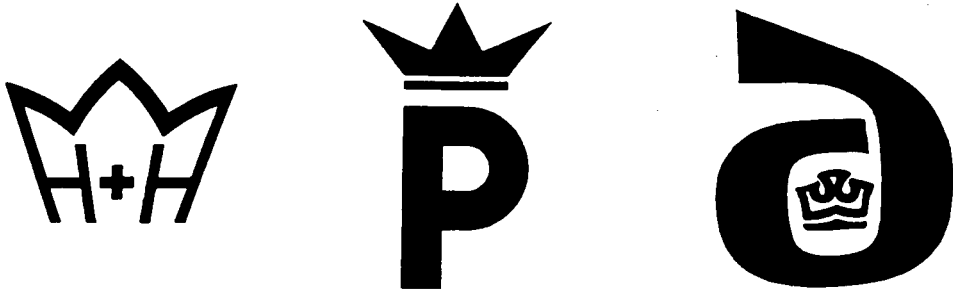

A 24.9.16 Crowns accompanied by another inscription



A 24.9.20 Crowns with representations of human beings or parts of the human body



A 24.9.21 Crowns with representations of animals or parts of animals' bodies

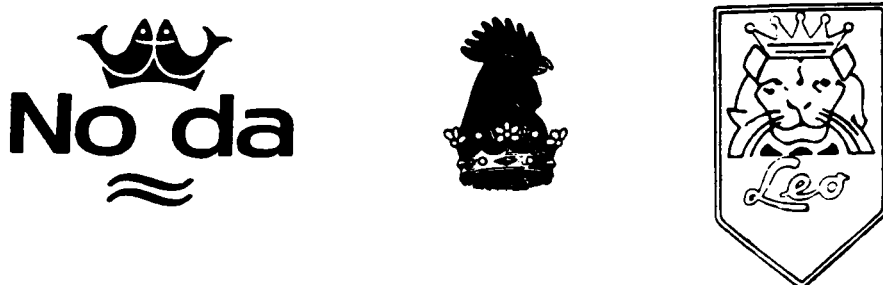

A 24.9.22 Crowns with representations of plants



A 24.9.23 Crowns with representations of manufactured or industrial articles

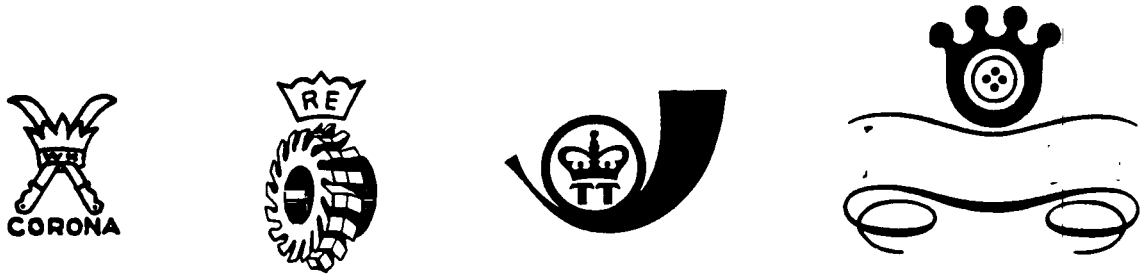

A 24.9.24 Crowns with another figurative element



A 24.9.25 Crowns presenting other characteristics



### Division 24.13: Crosses

#### 24.13.1 Greek cross, St. Andrew's cross

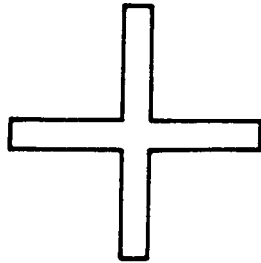

(Greek cross)

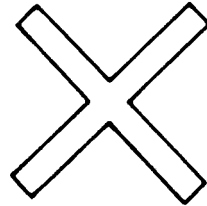

(St. Andrew's cross)

#### 24.13.2 Latin cross, tau cross

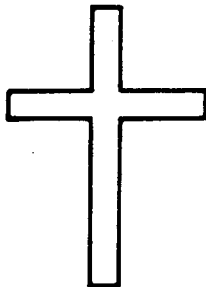

(Latin cross)

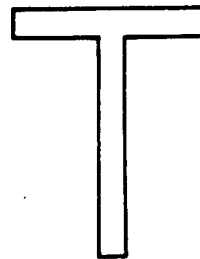

(Tau cross)

#### 24.13.3 Cross of Lorraine, Papal cross

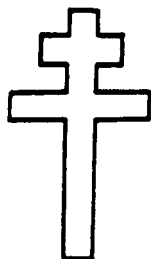

(Cross of Lorraine)

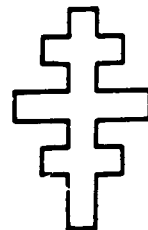

(Papal cross)



24.13.4 Maltese cross

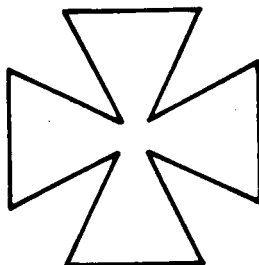

24.13.5 Crosses formed by inscriptions

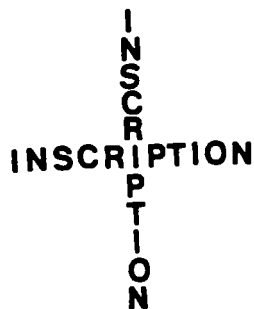

A 24.13.9 Crosses formed by intersecting lines

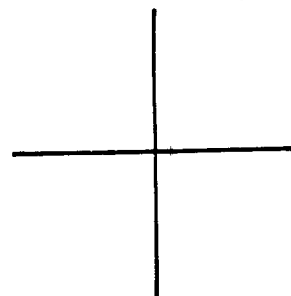
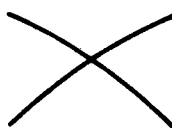
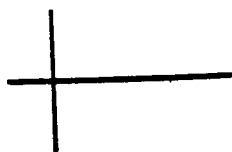

A 24.13.13 Crosses containing an inscription

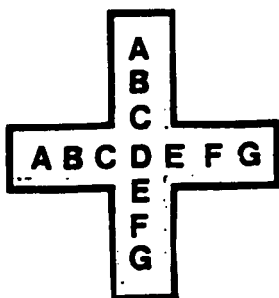

A 24.13.14 Crosses accompanied by an inscription

INSCRIPTION +

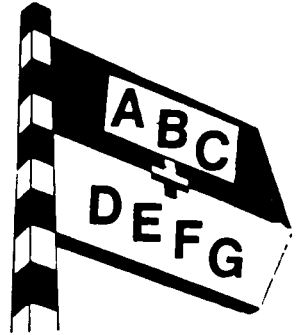

A 24.13.17 Crosses containing a figurative element



A 24.13.21 Crosses with rays or radiating lines

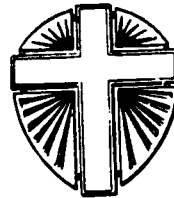

A 24.13.22 Crosses within a circle or a polygon

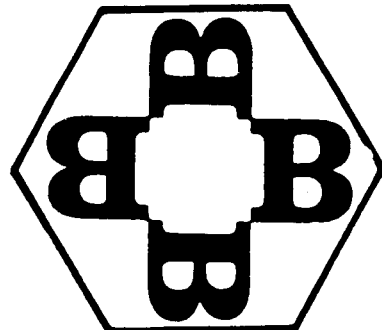

A 24.13.23 Crosses within a square or a rectangle

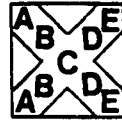

A 24.13.24 Crosses within any other figurative element



24.13.25 Other crosses

