



# **The Hague System for the International Registration of Industrial Designs**

## **Cross-Regional Online Workshop**

**Geneviève Steimlé**  
Legal Analyst and Information Officer  
Hague Development and Promotion Section  
**The Hague Registry**  
**World Intellectual Property Organization**

**IP for Women Entrepreneurs in the Industrial Design Sector**  
**Division for Transition and Developed Countries**  
**World Intellectual Property Organization**  
**April 12, 2023 – 10.25-11.00**

# Outline

- 1. Introduction**
- 2. Overview of the Hague System**
- 3. Filing through eHague**
- 4. Online Resources and Tools**
- 5. Hague System Statistics**
- 6. Conclusion**

**A simple concept**

**A centralized procedure**

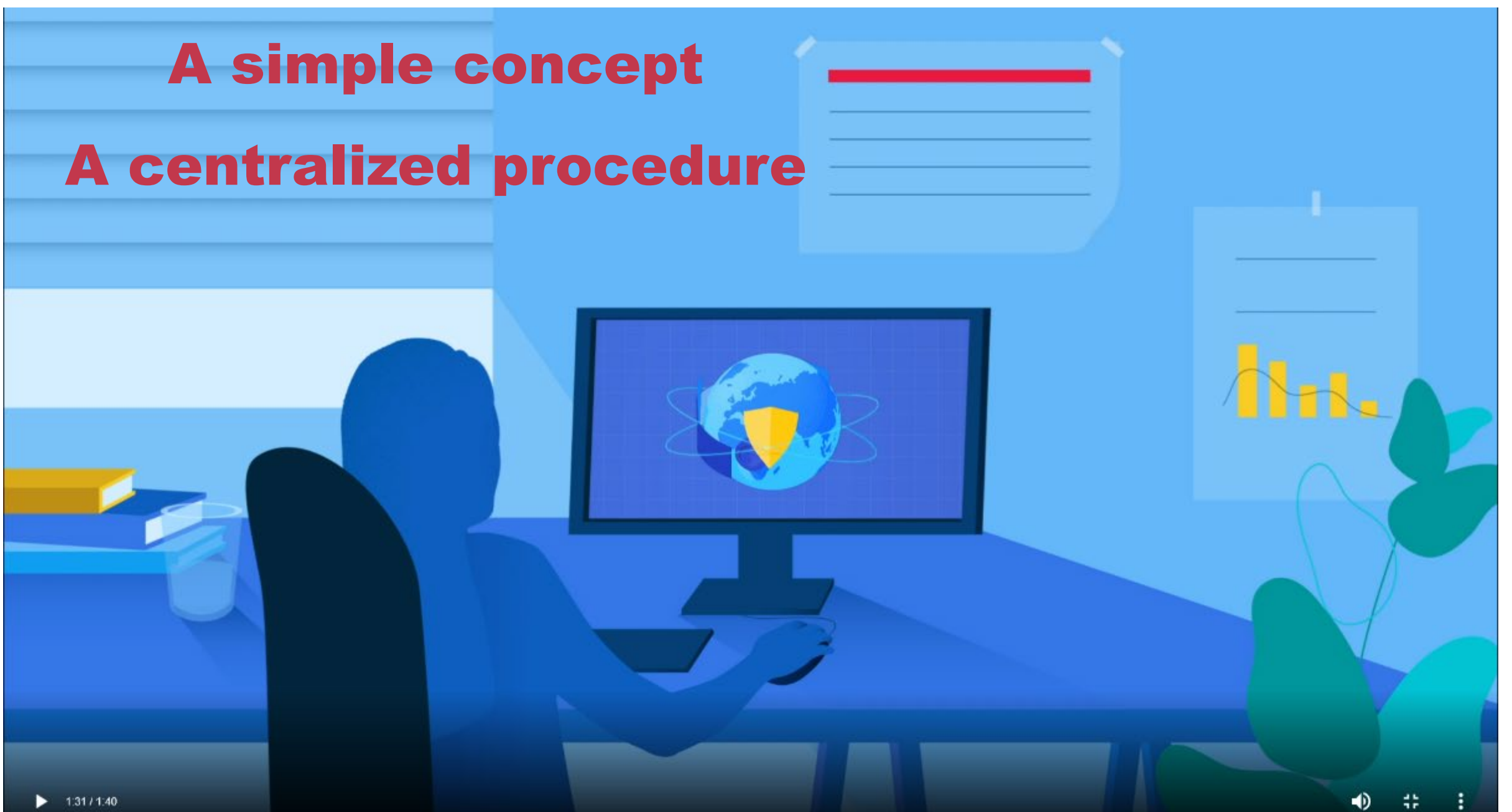

▶ 1:31 / 1:40



The International  
Design System

[https://www.wipo.int/hague/en/how\\_hague\\_works.html](https://www.wipo.int/hague/en/how_hague_works.html)

# **Part 1:**

## **Introduction**

# **Outline - Introduction**

- 1. What is an industrial design?**
- 2. What are industrial designs rights?**
- 3. Why protect industrial design?**
- 4. Examples of International Registrations.**



▶ 0:05 / 1:40



## 1-1. What is an industrial design?

**An industrial design constitutes the ornamental aspect of an article.**

**An industrial design may consist of three dimensional features, such as the shape of an article, or two dimensional features, such as patterns, lines or color.**

DM/208 110

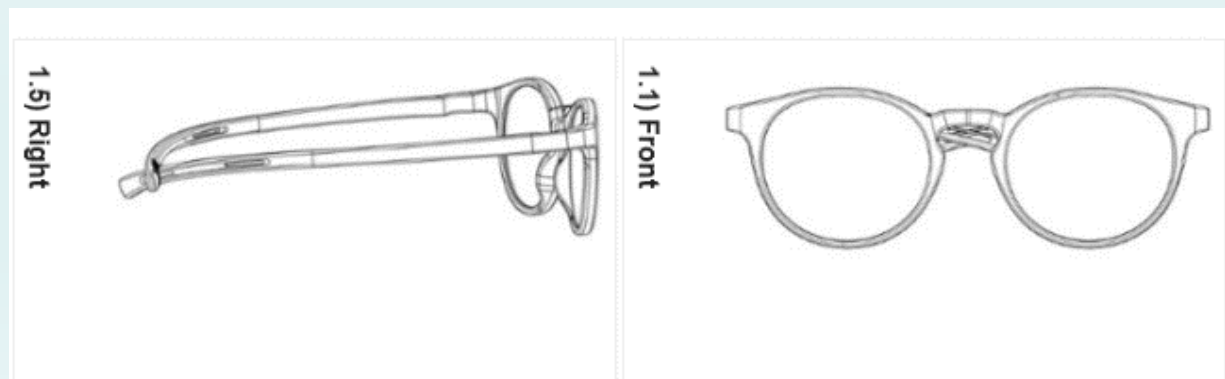

# DM/208 110

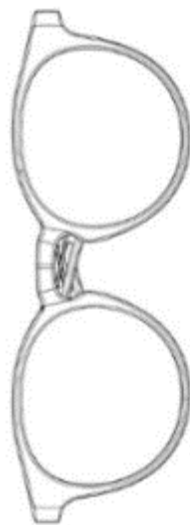

1.1) Front

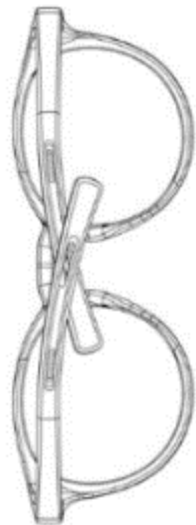

1.2) Back



1.3) Top



1.4) Bottom



1.5) Right



1.6) Left



1.7) Perspective





**constitutes the ornamental aspects of a product:  
shapes, patterns, lines, colors**

## **1-2. What are industrial design rights?**

**They are the rights that protect the ornamental aspects of a product: its shapes, patterns, lines or colors.**

**In principle, the owner of a registered industrial design has the right to prevent third parties from making, selling or importing articles bearing or embodying a design which is a copy, or substantially a copy, of the protected design, when such acts are undertaken for commercial purposes.**

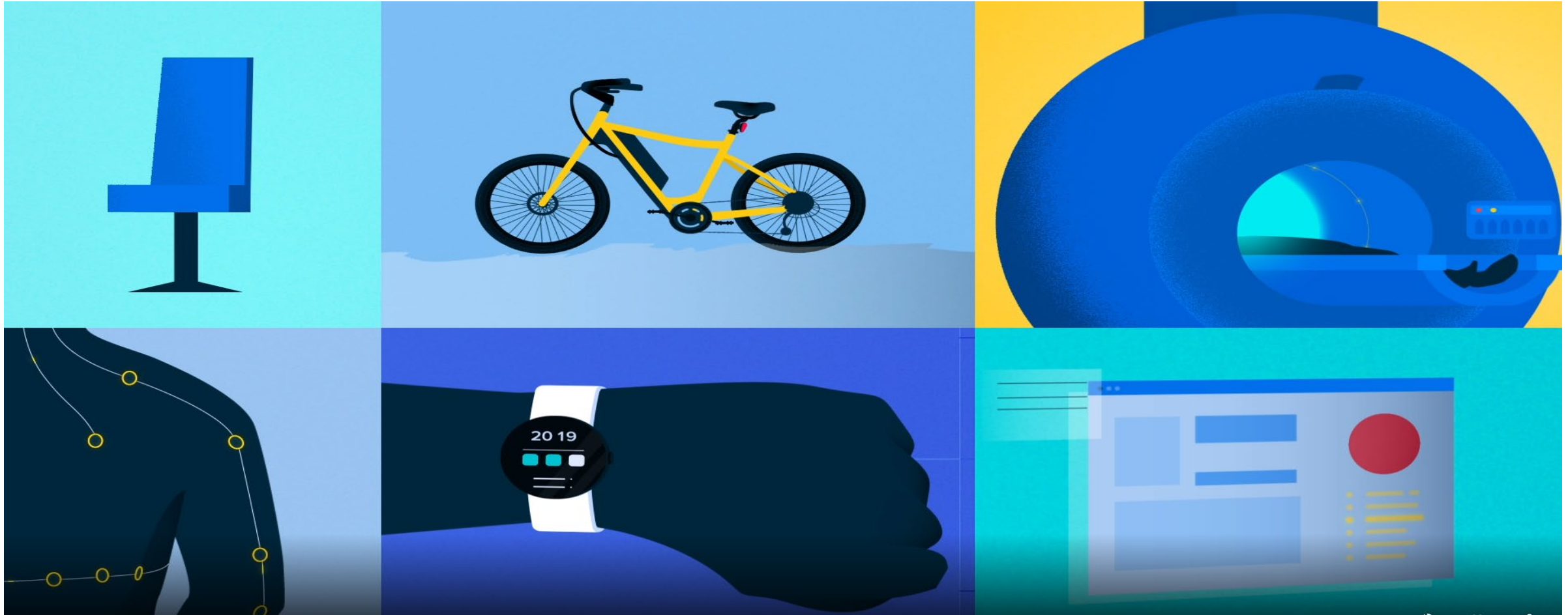

**protect the ornamental aspects of a product:  
shapes, patterns, lines, colors.**

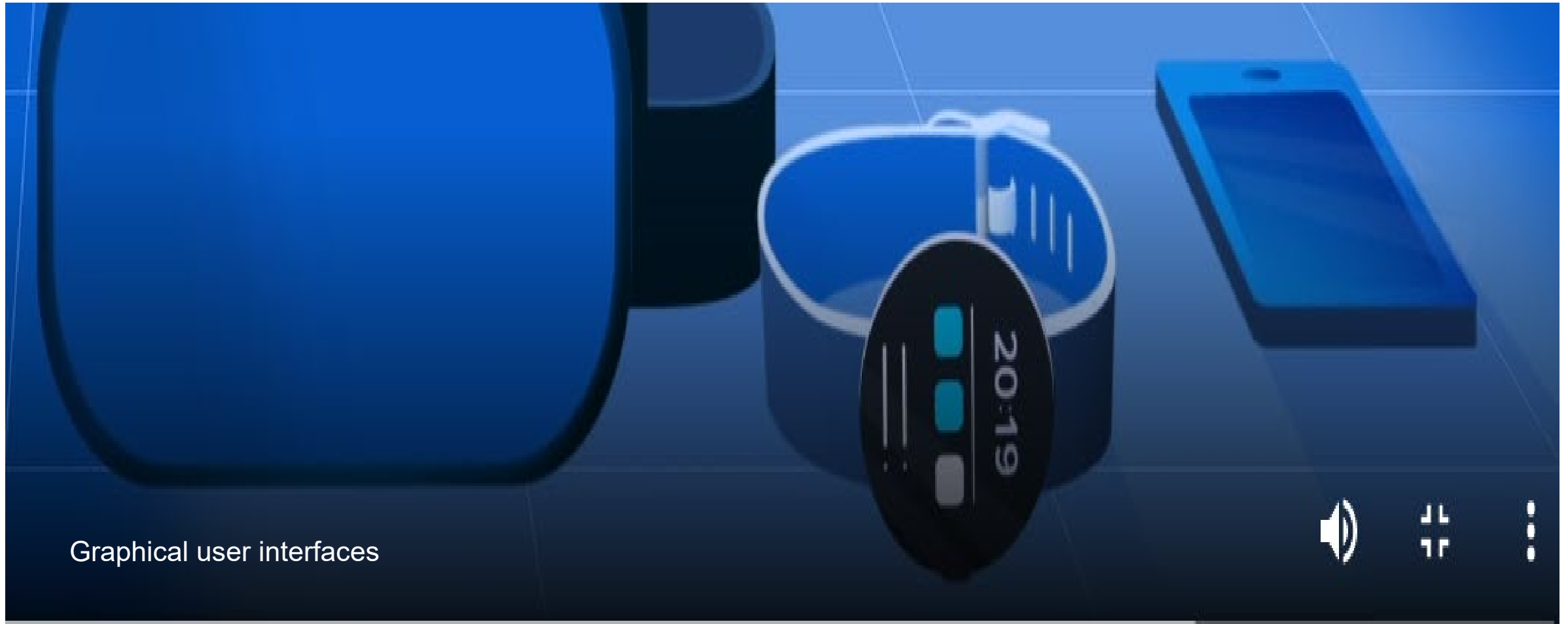

**protect the ornamental aspects of a product:  
shapes, patterns, lines, colors.**

# 1-3. Why protect industrial designs?



**Positive image**



**Obtain exclusive rights**



**Encourage creativity and fair competition**



**Enjoy Return on investment**



**Strengthens the commercial value of business**



**Opportunity to license/sell**

**1-4:**  
**Examples of International Registrations**

DM/086304



DM/214 805



DM/060547



DM/022 932



DM/216 130



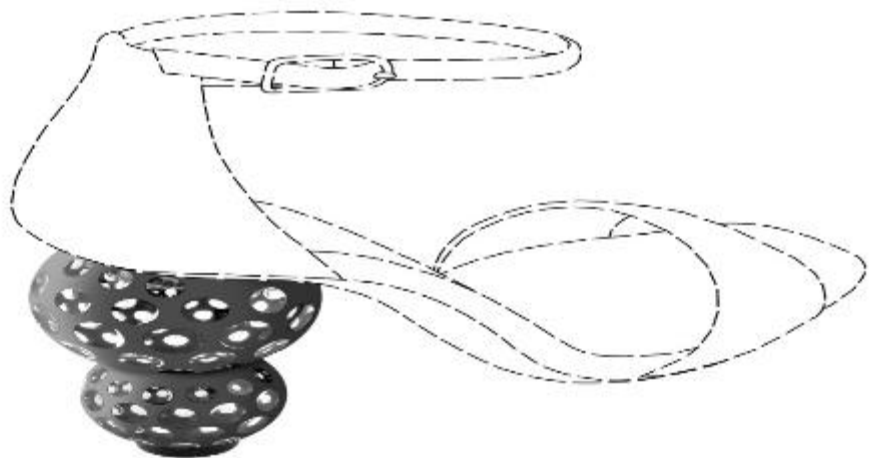

1.1



2.1

DM/213 194



3.1



4.1



**DM/209 780**

**CL. 06-01 (39 designs)**



# DM/209 780 CL. 06-01 (39 designs)



1.1) Front



1.2) Perspective



1.3) Perspectiva izquierda



1.4) Left



2.1) Front



2.2) Perspective



2.3) Perspectiva izquierda



2.4) Left



3.1) Front



3.2) Perspective



3.3) Perspectiva izquierda



3.4) Left

# DM/209 780 CL. 06-01 (39 designs)



24.1) Front



24.2) Back



24.3) Left perspective



24.4) Left



25.1) Front



25.2) Back



25.3) Left perspective



25.4) Left



26.1) Front



26.2) Back



26.3) Left perspective



26.4) Left

History

Designated contracting parties:

All CH EG EM SG TR UA US

DM/209 780

CL. 06-01 (39 designs)

Statement of Grant of Protection: EM: Bulletin No. 43/2020 PDF

(11) International registration number

DM/209 780

(81) Designated Contracting Party which made the notification, followed by the date on which protection was granted where that date was communicated to the International Bureau

EM; 05.10.2020

Current Status History

(24) Date on which the international registration produced the effect as a grant of protection under the applicable law

17.03.2020

Current Status

(58) Date of recording in the International Register

12.10.2020

Original Registration under 1999 Act : Bulletin No. 38/2020

Registration under 1999 Act

(11) International Registration Number

DM/209 780

(11) International Registration Number

DM/209 780

(15) Date of the international registration

17.03.2020

(15) Date of the international registration

17.03.2020

(18) Expected expiration date of the registration/renewal

17.03.2025

(18) Expected expiration date of the registration/renewal

17.03.2025





(22) Filing date

17.03.2020

(22) Filing date

17.03.2020

(73) Name and address of the holder(s)

|                          |           |  |            |       |                                  |                   |   |
|--------------------------|-----------|--|------------|-------|----------------------------------|-------------------|---|
| <input type="checkbox"/> | DM/227326 | Gesellschaft mit beschränkter Haftung<br>"Ehrmann" | 2023-02-22 | 32-01 | Graphic design [two-dimensional] | AM,KG,GE,MN,RS,TJ |    |
| <input type="checkbox"/> | DM/227327 | Gesellschaft mit beschränkter Haftung<br>"Ehrmann" | 2023-02-22 | 32-01 | Graphic design [two-dimensional] | AM,KG,GE,MN,RS,TJ |    |
| <input type="checkbox"/> | DM/227324 | Gesellschaft mit beschränkter Haftung<br>"Ehrmann" | 2023-02-22 | 32-01 | Graphic design [two-dimensional] | AM,KG,GE,RS,MN,TJ |    |
| <input type="checkbox"/> | DM/227325 | Gesellschaft mit beschränkter Haftung<br>"Ehrmann" | 2023-02-22 | 32-01 | Graphic design [two-dimensional] | AM,KG,GE,MN,RS,TJ |  |

**Name and address of creator of designs**

•1.Tamara - Moscow (RU)

**Name and address of creator of designs**

•1.Alina - Almaty (KZ)

**DM/227 324**



1) Front

**DM/227 325**



1) Front

**DM/227 326**



1) Front

**DM/227 327**



1) Front

Cl. 32-01

**Indication of products**

1.Graphic design [two-dimensional]

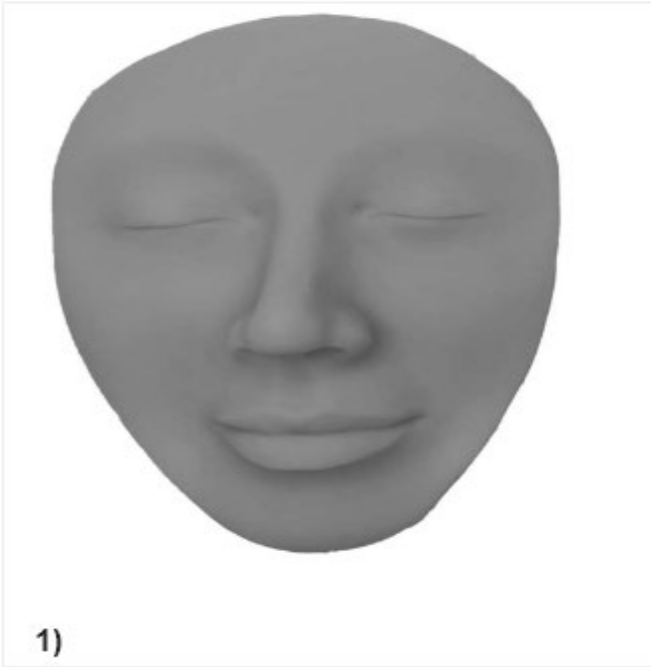

### DM/223 581

**Name and address of the holder**  
**Name and address of creator of designs:**

Olga  
 St. Petersburg (RU)  
 Cl. 19-07

**Indication of products**  
**1,2,3,4,5.**Medical simulator for training,  
 namely face sample for studying skin pigmentation

**Designated Contracting Parties:** US 1999

## History

### Designated contracting parties:

All US

### Original Registration under 1999 Act : Bulletin No. 39/2022

**(11) International Registration Number**

DM/223 581

**(15) Date of the international registration**

03.11.2021

**(18) Expected expiration date of the registration/renewal**

03.11.2026

**(22) Filing date**

03.11.2021

**(73) Name and address of the holder(s)**

Olga

194358 St. Petersburg (RU)

**(86) Contracting Party of which the holder is a national**

**i** RU

**(85) Contracting Party to the 1999 Act in the territory of which the holder has a habitual residence**

**i** RU

**(89) Applicant's Contracting Party**

**i** RU

**(74) Name and address of representative**

«INSTITUTE OF INNOVATION AND LAW», LLC/ MAKS YUREVICH LUTSKOVSKII  
а/я 200



**DM/215 042**  
**Cl. 28-03**  
**Holder for hair dryer**

**Name and address of the holder**  
**Name and address of creator of designs:**  
Elena  
Ekaterinburg (RU)

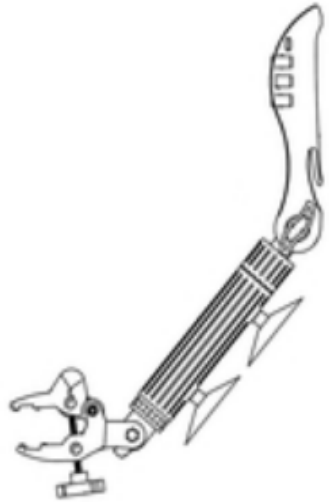

1.1) Left



1.2) Front



1.3) Back

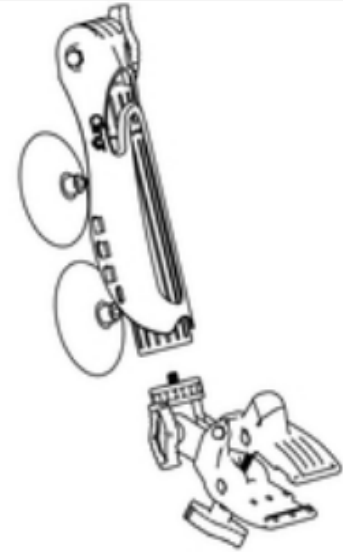

1.4) Perspective view folded and  
exploded

Designated contracting parties:

All AM AZ CA EM GB UA US

## Statement of Grant of Protection: CA: Bulletin No. 08/2023

**DM/215 042**  
**Cl. 28-03**  
**Holder for Hair Dryer**

(11) International registration number

 DM/215 042

(81) Designated Contracting Party which made the notification, followed by the date on which protection was granted where that date was communicated to the International Bureau

 CA; 09.02.2023

(24) Date on which the international registration produced the effect as a grant of protection under the applicable law

09.02.2023

(58) Date of recording in the International Register

11.02.2023

## Statement of Grant of Protection: AM: Bulletin No. 21/2022

(11) International registration number

 DM/215 042

(81) Designated Contracting Party which made the notification, followed by the date on which protection was granted where that date was communicated to the International Bureau

 AM; 20.05.2022

(24) Date on which the international registration produced the effect as a grant of protection under the applicable law

17.05.2022

(58) Date of recording in the International Register

20.05.2022

## Statement of Grant of Protection: EM: Bulletin No. 03/2022

(11) International registration number

 DM/215 042

(81) Designated Contracting Party which made the notification, followed by the date on which protection was granted where that date was communicated to the International Bureau

 EM; 05.01.2022

(24) Date on which the international registration produced the effect as a grant of protection under the applicable law

16.06.2021

(58) Date of recording in the International Register

07.01.2022

**DM/227 984**  
**CI. 20-03**  
**Shop sign**

**Name and address of the holder**  
**Name and address of creator of designs:**  
 Victoriia  
 43018 Lutsk, Volyn region (UA))

Designated contracting parties:

All EM

Current Status History

## Current Status

### Registration under 1999 Act

(11) International Registration Number  
DM/227 984

(15) Date of the international registration  
24.01.2023

(18) Expected expiration date of the registration/renewal  
24.01.2028

(22) Filing date  
24.01.2023

(73) Name and address of the holder(s)  
Victoriia  
43018 Lutsk, Volyn region (UA)

(86) Contracting Party of which the holder is a national  
UA

(87) Contracting Party in the territory of which the holder has a domicile  
UA

(89) Applicant's Contracting Party  
UA

(72) Name and address of creator of designs  
1. Victoriia Matviichuk  
73 Lvivska street, apartment 14  
43018 Lutsk, Volyn region (UA)

(28) Number of designs included in the international registration  
1

(51) Class and subclass of the Locarno Classification  
1. CI. 20-03

(54) Indication of products  
1. Shop sign / Enseigne de magasin / Letrero de tienda

(57) Description of the characteristic features of the design(s), or matter for which protection is not sought

1. The sign is claimed for registration as an industrial design; the appearance of the sign is shown in the image, reproduction 1.1 - front view; the industrial design is combined, it consists of graphic and verbal parts, made as an industrial design is a combination of white background and brown figure (RAL color code #8017) in the form of a circle with a white rim; the figure of a circle is symbolically divided in half by the image of another figure - the rolling pin, the rolling pin is made in a light brown color with an imitation of wood texture; in the lower part of the rolling pin, a white semicircle with indistinct edges is depicted, symbolizing flour; in the upper half



1) Front

**DM/227 981**  
**CI. 09-03**  
**Packaging box**

**Name and address of the holder**

**Name and address of creator of designs:**

Tetiana

22800 Nemyriv , Nemyrivskyj rajon, Vinnytska obl. (UA)

Registration under 1999 Act

(11) International Registration Number

DM/222 981

(15) Date of the international registration

15.08.2022

(18) Expected expiration date of the registration/renewal

15.08.2027

(22) Filing date

15.08.2022

Designated contracting parties:

All AM AZ BG EE LT LV MD PL RO TR



1.1) Perspective



1.2) Top



1.3) Front



1.4) Back



1.5) Left



1.6) Right

**DM/217 276**  
**CI. 13-03**  
**Switch [electricity]**

**Name and address of the holder**  
**Name and address of creator of designs:**  
Monika ... and Jacek ...  
5-110 Rajszew (PL)

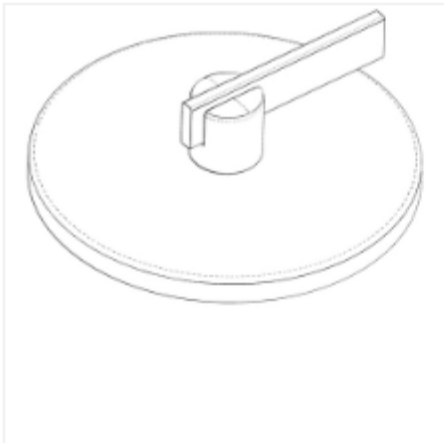

1.1) Perspective view (front, top)

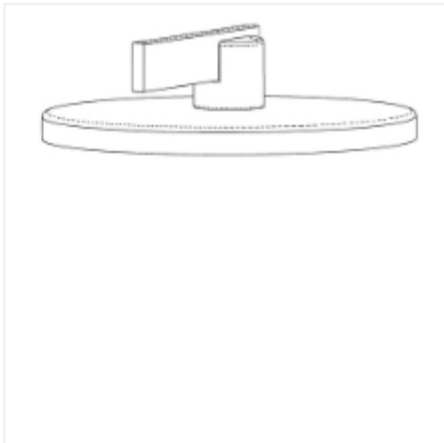

1.2) Perspective view (side view)



3.1) Perspective view (front, top)

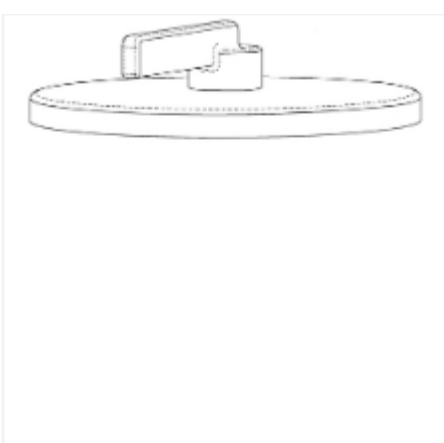

3.2) Perspective view (side view)



5.1) Perspective view (front, top)



2.1) Perspective view (front, top)



2.2) Perspective view (side view)



4.1) Pers

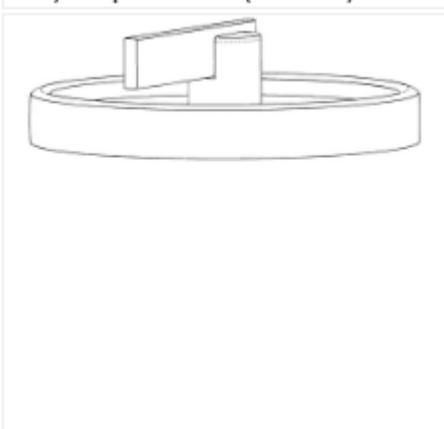

.2) Perspective view (side view)



5.2) Perspective view (side view)

# **Part 2:**

## **Overview of the Hague System**

# **Outline - Overview of the Hague System**

**1. What is the Hague System?**

**2. Main features and benefits**

**3. Geographical Scope**

**4. Legal Framework - A procedural Arrangement**

**5. Main Points of the procedure**

**6. Recent Developments**

## 2.1. What is the Hague System?

The Hague System provides a unique international mechanism for securing and managing design rights simultaneously in multiple jurisdictions, including:

**9/10**, Nine out of ten of the world's top economic market

**96** countries





**A simple concept**

**A centralized procedure**

# 2.2. Main Features & Benefits

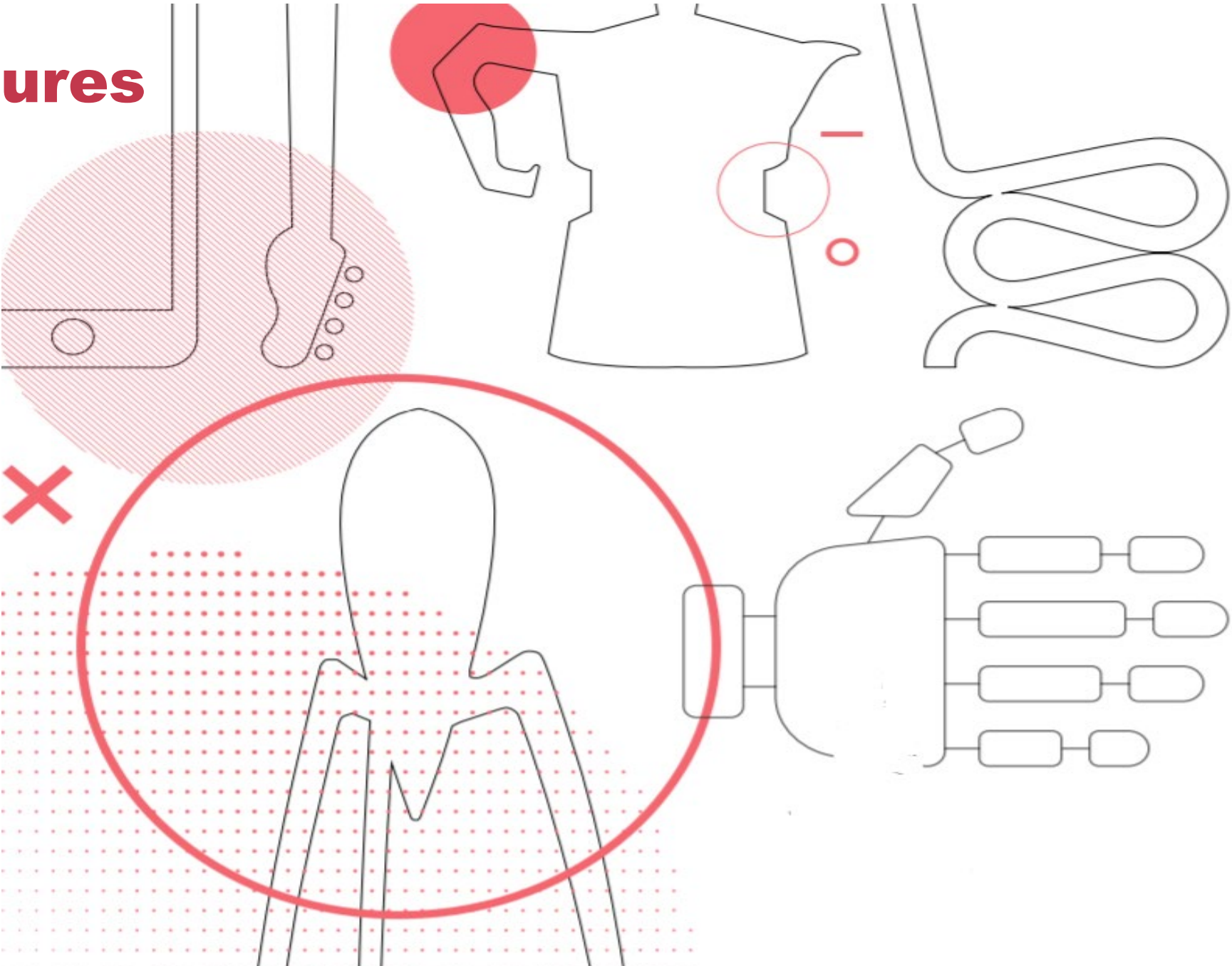

## **A unique business solution.**

- **Allow, through one international application,**
- **to protect, secure up to 100 designs**
- **in more than 90 countries,**
- **through a centralized management system**
- **In one currency.**

# Benefits of the Hague System



### Global

Protect your designs in over 90 countries, with more joining soon.



### Streamlined

One international application can include up to 100 designs.



### Economical

Save time and money thanks to the single application framework.



### Centralized

Easily manage your international design registrations directly with WIPO.

### *Efficient*

Access to different markets

Anywhere at any time

### *Belonging to the same Locarno Class*

- One language
- One set of fees
- One currency

### *Competitive*

- Cost and time effective:
- A procedure
- A scheme of rates in one currency

### *Simple*

- Centralized procedure and management (eHague, eRenewal)
- Intuitive: Mandatory formal requirements integrated



**Economical**

Save time and money thanks to the single application framework.

**5 designated Contracting Parties**

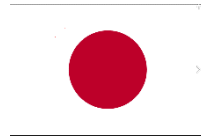

**Japan**



**EUIPO**

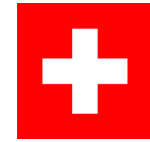

**Switzerland**



**US**



**United Kingdom**

**For 1 industrial design and 7 reproductions**

**14%**

**National/regional application fees**

**Total 2,637 CHF**

**Application Fees under the Hague System**

**Total 2,277 CHF**

**On average each applicant paid just over CHF 2,000 per registration in 2021**

# National or Regional Routes Outside the System



**5 IPO, 4/5 languages, 5 applications, 5 procedures, 5 registries, 5 renewals, 5 currencies...**

# The International route The Hague System



**1 IPO, 1 application, 1 language, 1 procedure, 1 registry, 1 renewal, 1 currency...**



## 2.3: Geographical scope







# Recent Accessions to the Geneva Act (1999)



**Brazil**  
**August 1, 2023**



**Jamaica**  
**February 10, 2022**



**Mauritius**  
**May 6, 2023**



**Mexico**  
**June 6, 2020**



**Morocco**  
**July 22, 2022**



**Israel**  
**January 3, 2020**



**China**  
**May 5, 2022**



**Suriname**  
**September 10, 2020**



**Belarus**  
**July 19 2021**

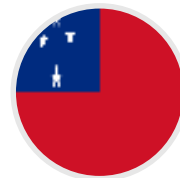

**Samoa**  
**January 2, 2020**

# Potential Accessions to the Geneva Act (1999)



**Trinidad and  
Tobago**



**Antigua y Barbuda**



**Indonesia**



**Jordan**



**Philippines**



**Lao People's  
Democratic Republic**



**Thailand**

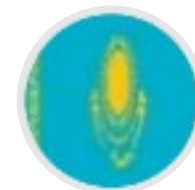

**Kazakhstan**



**Malaysia**



**Madagascar**



**Australia**

## 2.4

# Legal Framework – A procedural Arrangement



# The Hague System

## Hague Agreement Concerning the International Registration of Industrial Designs

of November 6, 1925.

- I. Hague Act 1960
- II. Complementary Act of Stockholm 1967  
as amended on September 28, 1979
- III. Geneva Act 1999

### Common Regulations

(as in force on January 1, 2022)  
and

### Administrative Instructions

(as in force on April 1, 2022)

Treaties

WIPO Publication No. 269E/22

2022



+ National  
laws and  
regulations

# The Hague Agreement

Hague Act (1960)

Geneva Act (1999)

**Common Regulations**

**Administrative instructions**

**National laws and regulations regulate:**

**the conditions of protection, the refusal procedure and  
the rights deriving from such protection**

# The Hague System

## A procedural arrangement

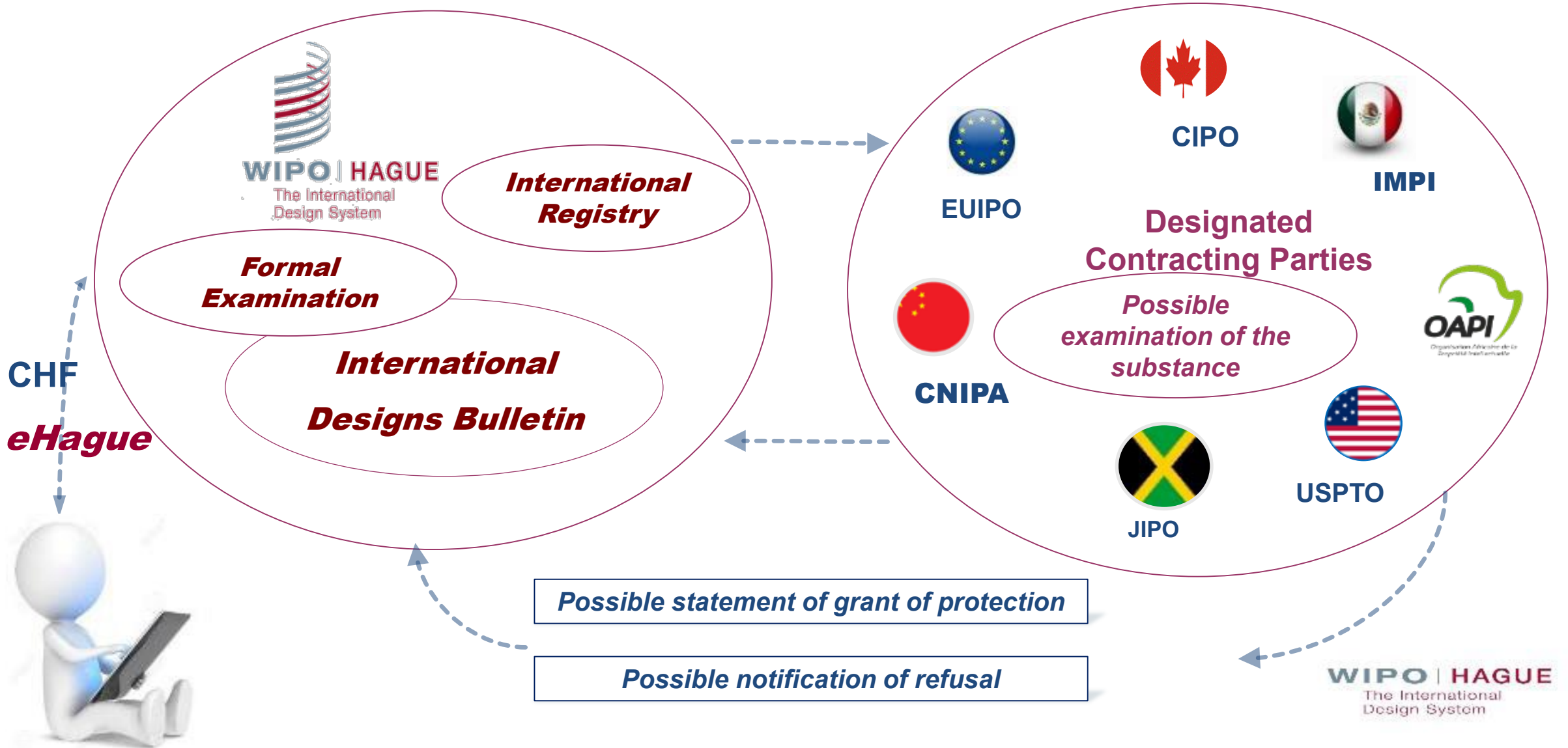



# WIPO's role

- 1. Sends the applicant an acknowledgment of receipt**
- 2. Formal examination of the application**
- 3. Notifies any irregularity to the applicant** (to be corrected within 3 months)
- 4. Records it in the International Register**
- 5. Issues the certificate of the international registration**
- 6. Publishes it in the *International Designs Bulletin*** (Notification to CP)
- 7. Notifies to holders of a possible refusal by a Contracting Party**
- 8. Manages the international registration**



# **Role of designated Contracting Parties**

- 1. Possible examination of the substance**
- 2. The laws of each designated Contracting Parties govern:**
  - 1. the conditions for obtaining protection**
  - 2. the substantive examination procedure**
  - 3. the refusal procedure (if any) and**
  - 4. the rights conferred by protection.**

# Possible Refusal

- **Only for substantive grounds;**

**Must be communicated to WIPO within a specified time frame**

**It does not affect protection in other designated Contracting Parties**

**the holder may resolve it before the IP office concerned**

**If there is no refusal: automatic granting of protection**

**The holder obtains a set of independent rights in all designated Contracting Parties**

# Examination of refusals by the International Bureau

- **Number of the international registration**
  - **The presence of ground(s) for refusal**
  - **Compliance with the prescribed period**
  - **If the conditions for refusal are met, the International Bureau registers it in the International Register and communicates it to the holder.**
- **If the refusal does not meet the conditions, it will not be recorded in the International Register and the OI will inform the holder and the national Office that issued the refusal.**

**2.5.**

**Main points of the procedure**



**Nationals of...**



**Anyone with a domicile**

**Who can use the system?  
Link to a contracting party**

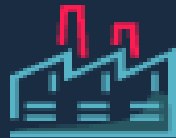

**Anyone with a real and effective industrial or commercial establishment in...**



**Anyone with a habitual residence in...**

# Main points of the procedure

- **No prior application or registration is required**
- **Electronic filing eHague and e-renewal interfaces are intuitive**
- **Possible to designate 79 Contracting Parties**
- **Up to 100 designs (of the same class) in the same international application**
- **Most international applications are filed directly with the International Bureau (not through an IP Office)**
- **Subsequent designation is not possible**

# Submitting an application

- **Directly to the International Bureau**  
(or through national offices of certain Contracting Parties: Japan, Republic of Korea, Russian Federation, United States)
- **Editable PDF form: DM/1**
  - In English, French or Spanish
  - Payment of a fixed fee in CHF
- **All contracting parties in which protection is sought must be designated (impossible to make designations later)**
- **Advisable to consult the declarations of designated contracting parties** (creator, postponement of publication, oath or certificate, special reproductions, claim, description...)

# Duration of protection

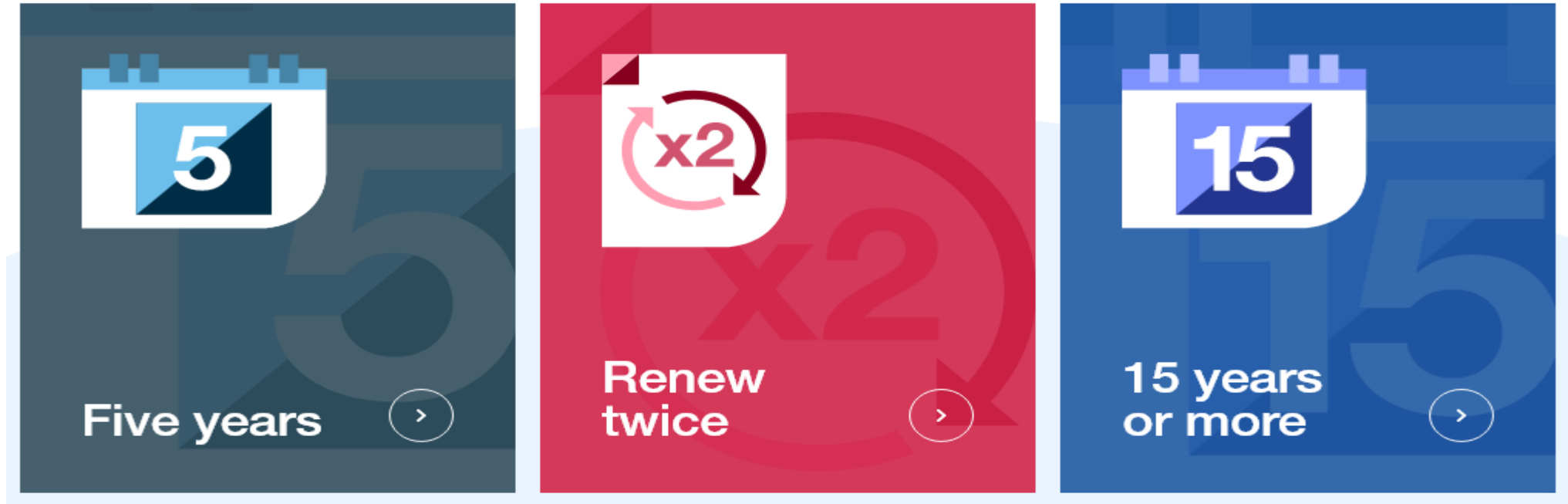

**Longer term of protection, if provided for by the law of the designated Contracting Party**

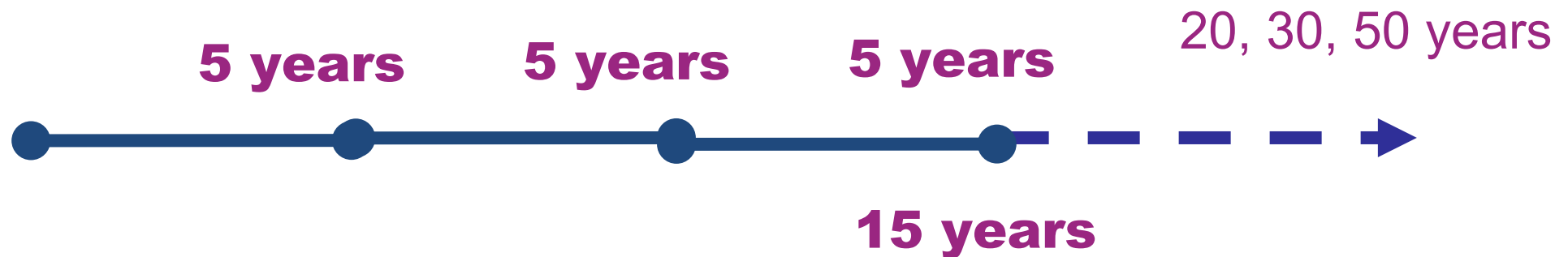



# **Same rights - same effects**

**As those resulting of a national or regional application  
submitted and registered at the national or regional level**

## **2.6.**

# **Recent Developments**

# Recent Legal Developments

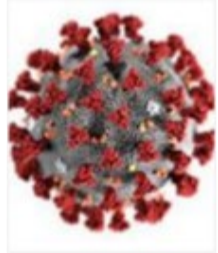

COVID-19 – Measures to address non-compliance with deadlines with the International Bureau due to force majeure (e.g. pandemic) (January 1, 2022)



Standard publication period extended from 6 to 12 months: (January 1, 2022)



Contact details:  
Tel number may be indicated  
Email address becomes mandatory  
(February 2021) (April 1, 2022)



Exclusive Use of Electronic Communications (March 28, 2022)



Update/modernization of signature  
Accepted formats for signature will now also include typed signature (including text-string signature through user-account) (April 1, 2022)

# Recent Legal Developments



WIPO DAS System for Priority Documents for International Applications under the Hague System (January 15, 2020)

CHANGE OF OWNERSHIP

Easier for a new owner to request the recording of the change in ownership procedure (January 1, 2022)



BREXIT



Entry into force of the 14th edition of the Locarno Classification entered into force on 1 January 2023



Publication in the Bulletin of any information concerning representatives to keep informed IPOs (April 1, 2023)

# Recent technologic improvements



**Launch of the eHague Portal  
Centralized Online access to Hague System services**



**WIPO Notifications Electronically since March 2020**



**Irregularity corrections can be submitted electronically**



**Payment method for WIPO services, with simultaneous integration**



**Digital Access Service (DAS) for sharing priority documents**

# WIPO Digital Access Service (DAS)

- **WIPO became a depositing office for International Applications under the Hague System with the WIPO DAS System for Priority Documents (January 15, 2020) (IN Hague No. 1/2020)**
- **Secure exchange of priority doc. between IP Offices participating in DAS**
- **The access code of the first application filed must be included, so that the designated office can directly access the priority document**
- **The code is obtained from the Office of first deposit, so that the Office of the designated Contracting Party can access the priority document**
- **Participating Offices: [https://www.wipo.int/das/en/participating\\_offices/](https://www.wipo.int/das/en/participating_offices/)**
- **How to join? <https://www3.wipo.int/contact/en/area.jsp?area=das>**

# **Part 3:**

## **Filing through eHague**

# Outline

- 1. WIPO IP Portal and eHague?**
- 2. Electronic filing interface**
- 3. Mandatory requirements**
- 4. Optional requirements**



# 4.1. WIPO IP Portal - ePortal

**WIPO IP PORTAL** MENU

HELP ENGLISH LOGIN **WIPO**

## WIPO IP Portal

### Easy access to all online IP Services

Find all services in the MENU and login with your WIPO Account for full access.

Create WIPO Account

Login

**Discover the new version of the WIPO IP Portal**  
A new design and additional information for an improved experience

**Current Account at WIPO**  
Your WIPO financial account that simplifies your transactions with WIPO services.

What are you looking for?



CLOSE

PATENTS &gt;

TRADEMARKS &gt;

**DESIGNS** >

GEOGRAPHICAL INDICATIONS &gt;

DIGITAL EVIDENCE &gt;

ASSISTANCE PROGRAMS &gt;

MEDIATION AND ARBITRATION &gt;

DOMAIN NAME DISPUTE RESOLUTION &gt;

PAYMENTS &gt;

Search &gt;

**File & Manage** >

Pay &gt;

IP Offices &gt;

Statistics &gt;

**eHague**

File and manage international applications to protect your designs and renew your international design registrations under the Hague System.

**Hague System Forms**

Access all official forms used under the Hague System.

**Fee Calculator**

Estimate the fees for filing an international application or the renewal of your international registration under the Hague System.

**Hague System Member Profiles**

Access information on the practices and procedures of Hague System members.

**Digital Access Service [DAS] for Applicants**

Register and manage priority documents for secure electronic exchange.

**Contact Hague**

Raise any queries about the Hague System, request certified copies or priority documents, submit [non-confidential] documents.

**WIPO Lex**

Free of charge access to legal information on intellectual property (IP).

**WIPO Academy**

The center of excellence for intellectual property (IP) education and training for WIPO member states.

## 4.2. What is eHague?

### ➤ **A digital gateway to:**

- File online industrial design applications anytime, anywhere
- Renew online industrial design registrations, securely and easily

### ➤ **An intuitive guide to the international registration procedure that allows to:**

- Integrate mandatory requirements,
- Automatically calculate rates,
- Have direct useful advice and
- important information on designated Contracting Parties

# WHAT IS eHAGUE?

eHague enables you to digitally and securely file your international design applications and renew your registrations.

You do not have to worry about what forms to fill out, what annexes are needed, or calculating fees by hand. Everything is done automatically based on the information you enter. The system guides you all the way, provides helpful hints and leads you to important information related to the process and to the specific contracting parties you are designating.

Filing through eHague will give you complete digital access to all aspects of your application. You can view and download your applications, reply to communications from WIPO, and make payments quickly and easily online. To manage your international registrations, use our [Hague System forms](#) (to be integrated into eHague in the future).

## eHAGUE SERVICES

**NEW!** – appoint or cancel a representative and change the contact details of an existing representative.

**NEW!** – view the status of your requests.

### FILE

Smartly file an application online anytime, anywhere.

Get started

### RENEW

Renew your registration the easy way.

Get started

### MANAGE REPRESENTATIVE

Appoint or cancel a representative

Get started

### MY WORKBENCH

Open my workbench

Get started

# 3.2. Electronic Filing Interface

## EHAGUE

|     |                      |               |                      |                 |
|-----|----------------------|---------------|----------------------|-----------------|
| New | Filed application(s) | Draft(s) [21] | eHague communication | eHague tutorial |
|-----|----------------------|---------------|----------------------|-----------------|

Applica

**New**

The application language determines notably the language of the registration certificate.

- New application
- New application using data from a filed application
- New application from a draft

### Warning

It is a requirement under the law of the United States of America that, for designs created in the United States of America, the applicant first obtains a license from the United States Patent and Trademark Office [USPTO] before filing outside of the United States of America.

It is a requirement under the law of the Russian Federation that designs created in the Russian Federation by Russian legal entities or nationals are subject to a security clearance procedure by the Federal Service for Intellectual Property [ROSPATENT] to ensure that the designs do not contain state secrets.











Confirm

New Filed application(s) **Draft(s) [21]** eHague con

Draft(s) [21]

[1 of 3]

1 2 3

| WIPO reference ▾ | Creation date ⇅ | Applicant(s) ⇅   | Locarno Class ⇅ | Designation(s) ⇅                       |   |
|------------------|-----------------|------------------|-----------------|--|---|
| WIPO114488       | 08/03/2022      |                  |                 |  |    |
| WIPO113400       | 09/02/2022      | Picapiedra Pedro | 11              | EM, MD, US                             |    |
| WIPO113333       | 08/02/2022      |                  |                 |  |    |
| WIPO102513       | 05/03/2021      |                  |                 |  |    |
| WIPO92059        | 12/02/2020      | Rodriguez Miguel | 14              | EM, IL, MX, US                         |    |
| WIPO92052        | 12/02/2020      |                  |                 |  |    |
| WIPO92012        | 10/02/2020      | bondad Alegria   | 2               | CA, ES, FR, GR, JP, KR, MA, RS, TJ, US |   |
| WIPO91801        | 03/02/2020      |                  |                 |  |  |
| WIPO91798        | 03/02/2020      |                  |                 |  |  |
| WIPO77912        | 06/12/2018      | Fancy Boxes      | 2               | CA, CH, CI, EM, OA, RU, SN, US         |  |

[1 of 3]

1 2 3



APPLICANT DESIGNATION DESIGN RELATED DESIGN DESCRIPTION CREATOR CLAIM PRIORITY EXHIBITION OPTIONAL CONTENT PUBLICATION SIGNATURE 1

# WIPO REFERENCE 89920 2

APPLICATION LANGUAGE : EN INEQ 4

Close

Summary

Payment/Validat. 3

▶ APPLICANT 5

▶ DESIGNATION

▶ DESIGN

▶ RELATED DESIGN

▶ DESCRIPTION

**If any mandatory requirement fields are missing, the user will not be able to validate is application.**

6

**Tip:** All sections become editable after an applicant, designation, and at least one design have been recorded.

## **4.4. Mandatory requirements**

- **Applicant references**
- **At least one designation of the contracting parties**
- **At least one reproduction (100 designs, unlimited reprod.)**
- **Indication of the product**
- **Signature of the applicant or his representative**
- **Payment of fees**

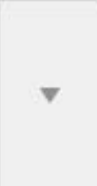

Name and address [Help](#)

|   |   |                                  |
|---|---|----------------------------------|
| Type<br><input type="radio"/> Legal Entity<br><input checked="" type="radio"/> Natural person | Address *   | Telephone [e.g +41 22 338 80 80] |
| Given name(s) *   | Zip/Post code   | E-mail address *                 |
| Family name *   | City *  | Address of website               |
|   | Region/State  |                                  |
|   | Country *  |                                  |

# At least one Designation of a Contracting Parties

## ▼ DESIGNATION

### DESIGNATED CONTRACTING PARTY(IES) [Help](#)

The international application must indicate at least one applicant  
Select at least one Contracting Party

Designations  
None

Change selection

Désignations  
Aucun

# At least one designation of a CP

Tout désélectionner Tout sélectionner

- |  |  |  |
|--|--|--|
| <input type="checkbox"/> AL Albanie                            | <input type="checkbox"/> AM Arménie                                    | <input type="checkbox"/> AZ Azerbaïdjan  |
| <input type="checkbox"/> BA Bosnie-Herzégovine                 | <input type="checkbox"/> BG Bulgarie <a href="#">info</a>              | <input type="checkbox"/> BN Brunéi Darussalam <a href="#">info</a>                                     |
| <input type="checkbox"/> BW Botswana                           | <input type="checkbox"/> BX Benelux <a href="#">info</a>               | <input type="checkbox"/> BY Bélarus <a href="#">info</a>   |
| <input type="checkbox"/> BZ Belize <a href="#">info</a>        | <input type="checkbox"/> CA Canada <a href="#">info</a>                | <input checked="" type="checkbox"/> CH Suisse <a href="#">info</a>                                     |
| <input type="checkbox"/> DE Allemagne                          | <input type="checkbox"/> DK Danemark <a href="#">info</a>              | <input type="checkbox"/> EE Estonie <a href="#">info</a>   |
| <input checked="" type="checkbox"/> EG Égypte                  | <input checked="" type="checkbox"/> EM Union européenne                | <input type="checkbox"/> ES Espagne  |
| <input type="checkbox"/> FI Finlande <a href="#">info</a>      | <input checked="" type="checkbox"/> FR France                          | <input type="checkbox"/> GB Royaume-Uni <a href="#">info</a>   |
| <input type="checkbox"/> GE Géorgie                            | <input type="checkbox"/> GH Ghana <a href="#">info</a>                 | <input type="checkbox"/> HR Croatie <a href="#">info</a>   |
| <input type="checkbox"/> HU Hongrie <a href="#">info</a>       | <input type="checkbox"/> IL Israël <a href="#">info</a>                | <input type="checkbox"/> IS Islande <a href="#">info</a>   |
| <input type="checkbox"/> JM Jamaïque <a href="#">info</a>      | <input type="checkbox"/> JP Japon <a href="#">info</a>                 | <input type="checkbox"/> KG Kirghizistan   |
| <input type="checkbox"/> KH Cambodge <a href="#">info</a>      | <input type="checkbox"/> KP République populaire démocratique de Corée | <input type="checkbox"/> KR République de Corée <a href="#">info</a>                                   |
| <input type="checkbox"/> LI Liechtenstein                      | <input type="checkbox"/> LT Lituanie                                   | <input type="checkbox"/> LV Lettonie   |
| <input type="checkbox"/> MC Monaco <a href="#">info</a>        | <input type="checkbox"/> MD République de Moldova                      | <input type="checkbox"/> ME Monténégro   |
| <input type="checkbox"/> MK la République de Macédoine du Nord | <input type="checkbox"/> MN Mongolie                                   | <input type="checkbox"/> MX Mexique <a href="#">info</a>   |
| <input type="checkbox"/> NA Namibie                            | <input type="checkbox"/> NO Norvège <a href="#">info</a>               | <input type="checkbox"/> OA Organisation africaine de la propriété intellectuelle <a href="#">info</a> |
| <input checked="" type="checkbox"/> OM Oman                    | <input type="checkbox"/> PL Pologne <a href="#">info</a>               | <input type="checkbox"/> RO Roumanie <a href="#">info</a>  |
| <input type="checkbox"/> RS Serbie <a href="#">info</a>        | <input type="checkbox"/> RU Fédération de Russie <a href="#">info</a>  | <input type="checkbox"/> RW Rwanda   |
| <input type="checkbox"/> SG Singapour <a href="#">info</a>     | <input type="checkbox"/> SI Slovénie <a href="#">info</a>              | <input type="checkbox"/> SM Saint-Marin  |
| <input type="checkbox"/> SR Suriname <a href="#">info</a>      | <input type="checkbox"/> ST Sao Tomé-et-Principe                       | <input checked="" type="checkbox"/> SY République arabe syrienne <a href="#">info</a>                  |
| <input type="checkbox"/> TJ Tadjikistan <a href="#">info</a>   | <input type="checkbox"/> TM Turkménistan                               | <input checked="" type="checkbox"/> TN Tunisie   |
| <input type="checkbox"/> TR Turquie <a href="#">info</a>       | <input type="checkbox"/> UA Ukraine <a href="#">info</a>               | <input type="checkbox"/> US États-Unis d'Amérique <a href="#">info</a>                                 |

**Click on the information icon [info](#) to find what effect the designation of a particular Contracting Party will have on the data you need to enter. The information will be displayed**

# At least one Reproduction of the Design



**A reproduction refers to photographs, drawings or other graphic representations that illustrate the designs**

- *Rule 9 of the Common Regulations Reproductions of the Industrial Design*
- *Part Four of the Administrative instructions: Requirements Concerning Reproductions and Other Elements of the International Application*

## **4.5. Optional requirements**

- **Creator references**
- **Description**
- **Legend(s)**
- **Claim of priority**
- **International Exhibition**
- **Publication (immediate or deferred)**

# **Part 4:**

## **Online Resources and Tools**

# **Outline: Online Resources and Tools**

- 1. Hague Webpage**
- 2. Hague System: Guide for Users**
- 3. Tips for Reproductions**
- 4. Hague System: Questions and Answers**
- 5. Hague System Member Profiles**
- 6. Online Databases**

1.



### How the Hague System works

Learn all about the process of securing international design protection.

#### Legal resources

- [Hague System legal texts](#)
- [Hague System Member Profiles](#)
- [Information notices](#)
- [Declarations by contracting parties](#)
- [Maximum duration of protection](#)
- [Hague System forms](#)
- [Order certified documents](#)



### Filing international design applications

File your international design applications online to have digital access to your portfolio.

#### User guides

- [Guide to the Hague System](#)
- [Preparing reproductions](#) [PDF](#)
- [Including multiple designs in an international application](#) [PDF](#)
- [Hague System electronic notifications](#)

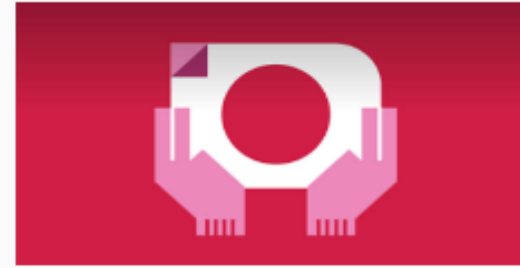

### Managing international design registrations

Update (transfer ownership, renunciation, limitation, etc.) and renew your international registration directly through WIPO.

#### Fees

- [Fees and payment methods](#)
- [Calculate your fees](#)
- [Online payment](#)

#### Design search tools

- [International Designs Bulletin](#)
- [Hague Express Database](#)
- [Global Design Database](#)
- [Locarno Classification](#)



### Searching protected designs

Check what your competitors are doing by searching existing designs before you file an international design application.

#### Meetings and training

- [Hague System Working Group](#)
- [Hague System webinars](#)
- [Distance learning](#)



2.



# Hague System Guide for Users

The **Hague System Guide for Users** is a comprehensive manual that explains the Hague System in detail. It combines legal and procedural information with cross references to all relevant legal citations.



## 3. Tips for reproductions

- **Guidance on Preparing and Providing Reproductions in Order to Forestall Possible Refusals on the Ground of Insufficient Disclosure of an Industrial Design by Examining Offices**  
[https://www.wipo.int/export/sites/www/hague/en/how\\_to/pdf/guidance.pdf](https://www.wipo.int/export/sites/www/hague/en/how_to/pdf/guidance.pdf)
- **Guidance on Including Multiple Designs in an International Application in Order to Forestall Possible Refusals**  
[https://www.wipo.int/export/sites/www/hague/en/docs/hague\\_system\\_guidance\\_multiple\\_designs.pdf](https://www.wipo.int/export/sites/www/hague/en/docs/hague_system_guidance_multiple_designs.pdf)

# 4.

## Hague System: Questions and Answers

(Latest revision: September 2022)

**Hot topic** – [Designating China in international applications](#)

Find out more...

- [Hague System Digital Information Kit](#)
- [Questions on eHague](#)
- [Questions on designs](#)

### A. Protecting your designs with the Hague System

<https://www.wipo.int/hague/en/faqs.html>

**Tip!** Designs can help you to differentiate your products from those of your competitors and obtain wider market recognition and visibility. Protection of designs (shape, form, patterns, lines or color of the ornamental part of your product) is essential. Exclusive rights – allowing you to license others to use your design for a fee – and protection against copying and counterfeits will strengthen your competitive position and the commercial value of your business and its products. This in turn will stimulate economic growth. [Find out more about designs.](#)

- ▶ [1. What is the Hague System?](#)
- ▶ [2. How can the Hague System help me?](#)
- ▶ [3. Can I use the Hague System?](#)

### B. International applications

#### ▼ [12. How many designs can my international application cover?](#)

You can include up to 100 designs per application. All designs **must** however belong to the same class of the International Classification for Industrial Designs (the [Locarno Classification](#)).

**Tip!** Some contracting parties require unity of design (for details, refer to [Declarations of Contracting Parties](#)). If this requirement is not met, they may refuse the effects of the international registration, pending compliance. **Find out more:** [Guidance on including multiple designs in one application.](#)

# HAGUE SYSTEM MEMBER PROFILES

Reset

Next

5.

Access a wide range of information on the practices and procedures of Hague System members. Select the members or relevant groupings. For complementary resources, consult the [Hague System website](#). Find out more about our Hague System Member Profiles.

1

Select members

2

Select details

3

Member information

All members

## HSMP – Information on the practices and procedures of Hague System members

[OA] African Intellectual Property Organization

[AL] Albania

[AM] Armenia

[AZ] Azerbaijan

[BY] Belarus

[BZ] Belize

[BX] Benelux

[BJ] Benin

[BA] Bosnia and Herzegovina

[BW] Botswana

[BR] Brazil

[BN] Brunei Darussalam

[BG] Bulgaria

[KH] Cambodia

[CA] Canada

[CN] China

[CI] Côte d'Ivoire

[HR] Croatia

[KP] Democratic People's Republic of Korea

[DK] Denmark

[EG] Egypt

[EE] Estonia

[EM] European Union

[FI] Finland

[FR] France

[GA] Gabon

[GE] Georgia

[DE] Germany

[GH] Ghana

[GR] Greece

[HU] Hungary

[IS] Iceland

[IL] Israel

[IT] Italy

[JM] Jamaica

[JP] Japan

[KG] Kyrgyzstan

[LV] Latvia

[LI] Liechtenstein

[LT] Lithuania

[ML] Mali

[MU] Mauritius

[MX] Mexico

[MC] Monaco

[MN] Mongolia

[ME] Montenegro

[MA] Morocco

[NA] Namibia

[NE] Niger

[MK] North Macedonia

[NO] Norway

[OM] Oman

[PL] Poland

[KR] Republic of Korea

[MD] Republic of Moldova

[RO] Romania

[RU] Russian Federation

[RW] Rwanda

[WS] Samoa

[SM] San Marino

[ST] Sao Tomé and Príncipe

[SN] Senegal

[RS] Serbia

[SG] Singapore

[SI] Slovenia

[ES] Spain

[SR] Suriname

[CH] Switzerland

[SY] Syrian Arab Republic

[TJ] Tajikistan

[TN] Tunisia

[TR] Türkiye

[TM] Turkmenistan

[UA] Ukraine

[GB] United Kingdom

[US] United States of America

[VN] Viet Nam

Selected members 25 / 77

## 6. Online databases

### Global Design Database

Browse through the millions of designs that exist under the Hague System and in the collections of participating offices, including China, the EU, Japan, the Republic of Korea, and the USA.

### Hague Express

Search our weekly updated database of all international registrations.

# Global Design Database

A world-wide collection of industrial designs data; including WIPO Hague registrations and information from participating offices.

searches records

## SEARCH BY

Design Names Numbers Dates Country Priority

Indication of Product =

Design class =

Description =

search

## FILTER BY

Source Status Designation Locarno Class Reg. Year \* Expiration \* Holder \*

|            |         |            |           |            |           |
|------------|---------|------------|-----------|------------|-----------|
| AL Designs | 297     | BN Designs | 191       | BW Designs | 203       |
| CA Designs | 181,038 | CH Designs | 130,581   | CN Designs | 6,253,162 |
| CR Designs | 1,938   | DE Designs | 1,223,519 | EM Designs | 1,406,689 |
| ES Designs | 464,723 | FR Designs | 784,049   | GE Designs | 2,531     |
| ID Designs | 52,461  | IN Designs | 63,318    | IT Designs | 49,132    |
| JP Designs | 598,850 | JO Designs | 2,193     | KE Designs | 1,225     |

Display: List

Sort: Value - asc

filter

1 - 10 / 13,393,955

DESIGN view



Display: 10

per page

options



1

/ 1,339,396



Sort by Reg. Date - desc

NZ ID

428724

FLUID CONNECTOR

2021-04-01

KPR U.S., LLC

NZ ID

428723

FLUID CONNECTOR

2021-04-01

KPR U.S., LLC

NZ ID

428722

FLUID CONNECTOR

**With international registrations under The Hague System**

**With national or regional registries at participating national or regional offices**

**Search for any registered designs**

# HAGUE EXPRESS

The Hague Express Database, updated weekly, includes bibliographical data and, as far as international registrations governed exclusively or partly by the 1999 and/or by the 1960 Act(s) of the Hague Agreement are concerned, reproductions of industrial designs relating to published bearing a registration date as from January 3, 1985. International registrations that have lapsed are not removed from the database.

searches ▾ records ▾

**SEARCH BY**

Design Names Numbers Dates Country

Indication of Product ▾ =

Locarno Class =

Description ▾ =



**FILTER BY**

Designation Locarno Class Reg. Year \* Contracting Party \* Expiration \*

|    |        |    |        |    |        |    |        |    |        |    |        |
|----|--------|----|--------|----|--------|----|--------|----|--------|----|--------|
| CH | 76,121 | BE | 57,593 | LU | 57,590 | NL | 57,586 | BX | 57,584 | FR | 56,361 |
| DE | 56,008 | IT | 51,776 | ES | 41,204 | EG | 39,215 | TN | 39,172 | ID | 34,951 |
| MA | 34,539 | VA | 32,911 | EM | 32,320 | AN | 31,674 | MC | 23,619 | LI | 22,900 |
| HU | 15,617 | TR | 15,055 | GR | 12,047 | US | 11,695 | UA | 9,719  | RO | 9,656  |
| SI | 9,635  | SG | 9,577  | ME | 9,108  | RS | 8,933  | MK | 8,913  | KP | 8,086  |
| MD | 7,784  | NO | 7,753  | DD | 7,357  | CW | 6,974  | BQ | 6,974  | SX | 6,973  |
| VN | 6,517  | JP | 6,322  | KR | 5,853  | BG | 5,578  | HR | 5,066  | MN | 5,006  |
| SN | 4,713  | SR | 4,605  | YU | 4,486  | GE | 3,949  | BJ | 3,948  | KG | 3,189  |

Display: List Sort: Count - desc

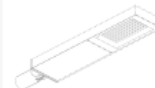
1 - 10 / 111,614  10 per page 1 / 11,162

|                          | Reg. No   | Holder           | Reg. Date  | Locarno Cl. | Ind. Prod.                | Designations | Image   |
|--------------------------|-----------|------------------|------------|-------------|---------------------------|--------------|---|
| <input type="checkbox"/> | DM/212992 | URBIDERMIS, S.L. | 2021-03-01 | 26-05       | Support for light fixture | US,EM,GB     |  |
| <input type="checkbox"/> | DM/212993 | URBIDERMIS, S.L. | 2021-03-01 | 26-05       | Light fixture             | US,EM,GB     |  |

**Search for registered international designs**

# **Part 5.**

# **Statistics**





# Hague System Statistics

Access WIPO's extensive statistical  
data on designs worldwide.

# WIPO IP Statistics Data Center

Source: WIPO statistics database. Last updated: January 2023

[Key indicators](#)[Patent](#)[Trademark](#)[Industrial design](#)[Utility model](#)[Geographical indications](#)[PCT](#)[Madrid](#)[Hague](#)[Saved searches](#)

Indicator



Report type



Year range



# The Hague System Statistics – 2020/2021

## 2020

|                                  |               |
|----------------------------------|---------------|
| <b>Applications:</b>             | <b>5.799</b>  |
| <b>Registrations:</b>            | <b>6.795</b>  |
| <b>Designs in applications:</b>  | <b>18.580</b> |
| <b>Designs in registrations:</b> | <b>23.671</b> |

## 2021

|                                  |               |
|----------------------------------|---------------|
| <b>Applications:</b>             | <b>6.711</b>  |
| <b>Registrations:</b>            | <b>6.106</b>  |
| <b>Designs in applications:</b>  | <b>22.486</b> |
| <b>Designs in registrations:</b> | <b>19.993</b> |

# The 5 most used international registration classes in 2021

1°



**Class 12**  
Mains of transport

2°



**Class 14**  
Recording and communication equipment

3°



**Class 9**  
Packages and containers

4°



**Class 6**  
Furnishing

5°



**Class 26**  
Lighting apparatus

Number of designs

2.179  
9,7%

2.154  
9,6%

1.847  
8.2%

1.548  
6,9%

1.457  
6,5%

## 6. Designs contained in designations in international applications for the top 10 designated Hague members, 2021

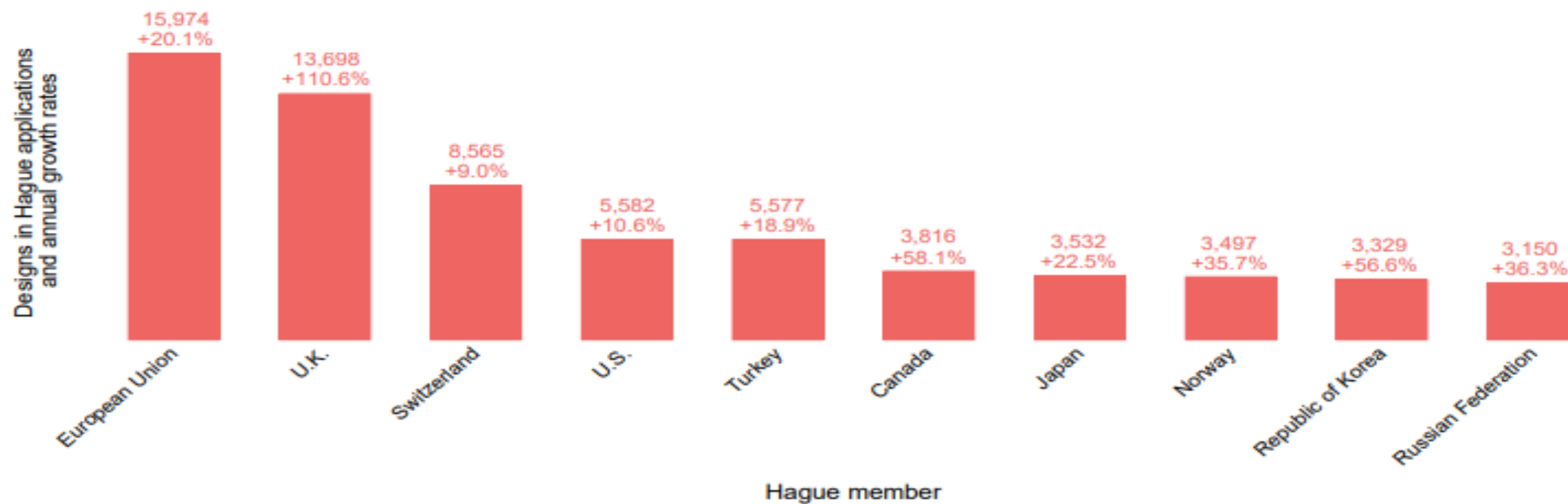

Source: WIPO Statistics Database, February 2022.

# **Part 6:**

# **Conclusion**

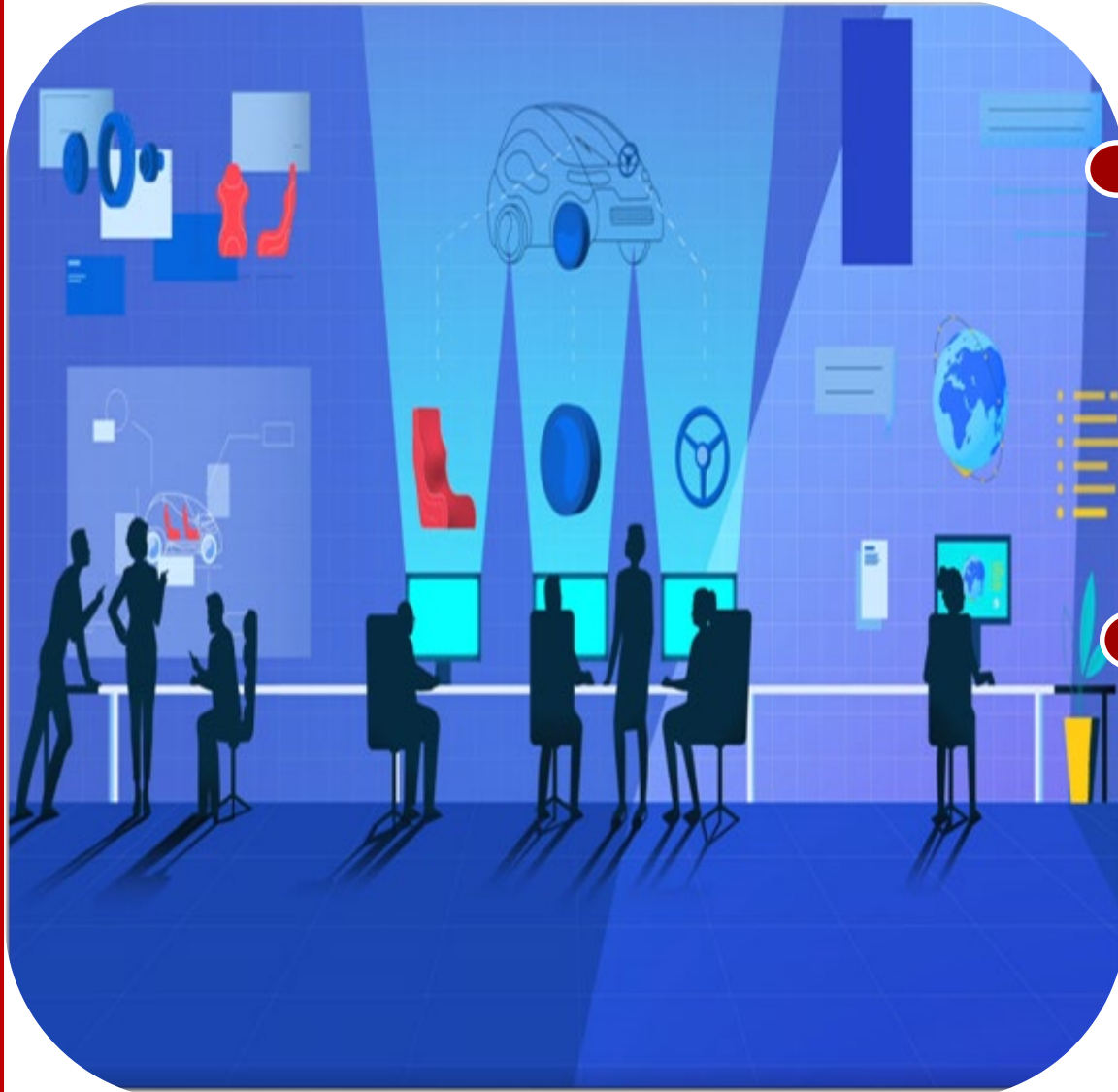

The Hague System provides a **straightforward solution to international design protection** that **eliminates the need to file separate and multiple applications** in individual countries or regions.

IP rights are territorial – **the domestic laws of each contracting party govern the protection** resulting from international registrations

**A simple concept**

**A centralized procedure**

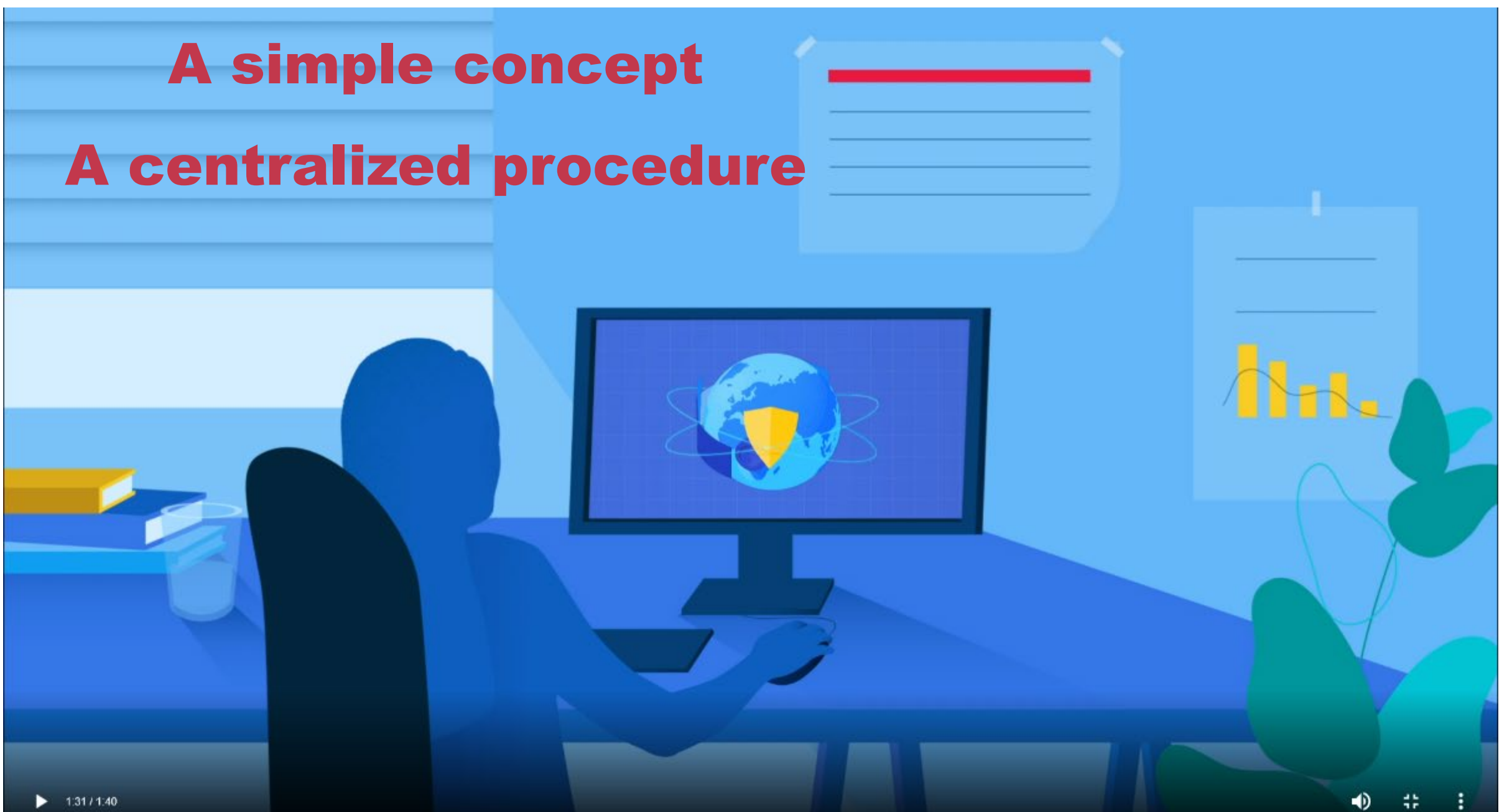

▶ 1:31 / 1:40



The International  
Design System

[https://www.wipo.int/hague/en/how\\_hague\\_works.html](https://www.wipo.int/hague/en/how_hague_works.html)



# Contact Hague

Use this form to make an enquiry, submit documents or to request a priority document.

I am:\*

**Assisting you throughout the lifecycle of your international design applications and registrations**

## Need help?

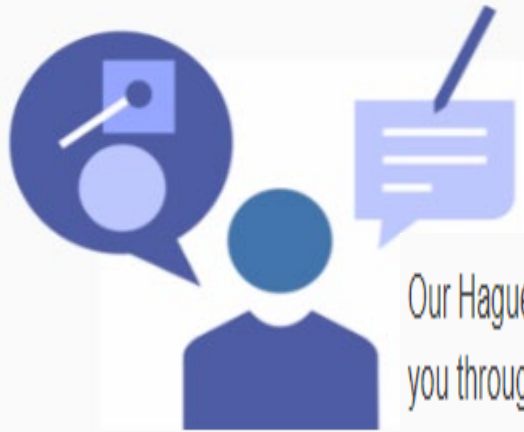

Our Hague Customer Service team is available to answer all your questions and queries and to assist you throughout the lifecycle of your international design applications and registrations. To ensure optimal handling of enquiries use Contact Hague.

Submit

## Hague Customer Service

- Tel: +41 22 338 7575 (Monday to Friday – 9:00-18:00 Central European Time (CET))

WIPO official holidays

## Want to send us documents?

Access [Hague System Document Upload](#) using your WIPO Account. [Upload instructions.](#)

## Email updates

[Hague News](#) – [Information Notices](#) and updates on developments in the Hague System.

Sign up



# The Hague | WIPO

<https://www.wipo.int/hague/en/>



**Many thanks**